

Daedal

Manual No. 100-5326-01
Rev. 8

MX80L Precision Grade MX80L Standard Grade Product Manual

Effective: July 11, 2011
Supersedes: March 1, 2011



Electromechanical Positioning Systems



Important User Information

WARNING

FAILURE OR IMPROPER SELECTION OR IMPROPER USE OF THE PRODUCTS AND/OR SYSTEMS DESCRIBED HEREIN OR RELATED ITEMS CAN CAUSE DEATH, PERSONAL INJURY AND PROPERTY DAMAGE.

This document and other information from Parker Hannifin Corporation, its subsidiaries, and authorized distributors provide product and/or systems options for further investigation by users having technical expertise. It is important that you analyze all aspects of your application and review the information concerning the product or system in the current product catalog. Due to the variety of operating conditions and applications for these product systems, the user, through its own analysis and testing, is solely responsible for making the final selection of the products and systems and assuming that all performance, safety, and warning requirements of the application are met.

The products described herein, including without limitation, product features, specifications, designs, availability and pricing, are subject to change by Parker Hannifin Corporation and its subsidiaries at any time without notice.

The information in the product manual, including any apparatus, methods, techniques, and concepts described herein, are the proprietary property of Parker Hannifin Corporation, Daedal Division or its licensors, and may not be copied, disclosed, or used for any purpose not expressly authorized by the owner thereof.

Since Parker Hannifin Corporation, Daedal Division constantly strives to improve all of its products, we reserve the right to change this product manual and equipment mentioned therein at any time without notice.

.....
• *For assistance contact:*
• Parker Hannifin Corporation
• Daedal Division
• 1140 Sandy Hill Road
• Irwin, PA 15642
• Phone: 724/861-8200
• 800/245-6903
• Fax: 724/861-3330
• E-mail: ddlcat@parker.com
• Web site: www.daedalpositioning.com
.....

MX80L Series Product Manual

Table of Contents

IMPORTANT USER INFORMATION..... 2

TABLE OF CONTENTS..... 3

REVISION NOTES..... 5

CHAPTER 1 - INTRODUCTION 6

 PRODUCT DESCRIPTION 6

MX80L POSITIONER..... 6

 UNPACKING 6

 RETURN INFORMATION..... 7

RETURNS..... 7

 REPAIR INFORMATION..... 7

OUT-OF-WARRANTY REPAIR..... 7

 WARNINGS AND PRECAUTIONS 7

 SPECIFICATION CONDITIONS 8

 ASSEMBLY DIAGRAM 9

CHAPTER 2 – MX80L SERIES TABLE SPECIFICATIONS 10

 ORDER NUMBER NOMENCLATURE 10

 DIMENSIONAL DRAWINGS..... 11

 GENERAL TABLE SPECIFICATIONS..... 14

 TEST METHODOLOGY 15

 MX80L SERIES TECHNICAL DATA..... 16

 LINEAR MOTION GUIDE BEARING LIFE/LOAD COMPUTATION 21

 MX80L SERIES TECHNICAL DATA..... 22

 MX80L SERIES TECHNICAL DATA..... 22

 BLANK PAGE..... 23

 ELECTRICAL SPECIFICATIONS..... 24

 CLEAN ROOM PREPARATION 25

 ENCODER SPECIFICATIONS 26

 HALL EFFECT SPECIFICATION..... 26

 LIMIT AND HOME SENSOR SPECIFICATIONS..... 26

 LOW ESD SPECIFICATIONS..... 26

 DRIVE SPECIFICATIONS..... 26

 STANDARD CABLING AND WIRING DIAGRAMS 27

 COMPAX3 CABLING AND WIRING DIAGRAMS 28

CHAPTER 3 - HOW TO USE THE MX80L 29

 MOUNTING ORIENTATIONS 29

 MOUNTING SURFACE REQUIREMENTS 29

 LOAD MOUNTING REQUIREMENTS..... 30

 LIMIT AND HOME SENSOR OPERATION..... 31

 ADJUSTING THE LIMIT FLAG PROCEDURE..... 32

 SETTING HOME SENSOR..... 33

 Z CHANNEL POSITION REFERENCE 33

 GROUNDING / SHIELDING 34

 CABLING 34

 CABLE MANAGEMENT 35

 PNEUMATIC COUNTERBALANCE 35

CHAPTER 4 - PERFORMANCE..... 36

 ACCELERATION LIMITS..... 36

 SPEED LIMITS 36

 THERMAL EFFECTS ON ACCURACY..... 37

 THERMAL EFFECTS ON REPEATABILITY..... 37

 CAUSES OF TEMPERATURE INCREASES 38

 COMPENSATING FOR THERMAL EFFECTS..... 38

CHAPTER 5 - CONNECTING TO THE VIX..... 39

CHAPTER 6 - MAINTENANCE AND LUBRICATION..... 40

CROSS ROLLER BEARING LUBRICATION 40

APPENDIX A - INTERNAL PROTECTION..... 41

NOTE: NUMBER INDICATORS ABOVE REPRESENT ONLY A PARTIAL LIST OF IP RATING SPECIFICATIONS..... 41

APPENDIX B - EC DECLARATION OF CONFORMITY 42

INDEX 43

Revision Notes

Revision 1
Original Document

Revision 2 – 8/25/03

General

Made numerous spelling corrections

Added precision grade tables

Page 9 – Modified configurable to include precision grade tables

Page 13 – Modified specifications to include precision grade tables

Page 25 – Modified Low ESD description to include precision grade tables

Revision 3

Changed wiring block extension dimension on page 10

Page 29, 30, & 31, Changed Limits/Home from optical sensors to magnetic sensors

Revision 4

Removed Steps 5a & 5b from page 30 (Steps 5a & 5b were for optical Limits/Home)

Revision 5

Added information for the T05 (200mm travel) positioner

Revision 6

Updated electrical specification for the resistance and inductance on D11 and D13 motors, page 23.

Added the following Note to page 26: Tables purchased before June 1, 2009 require an interpolator box and a bypass cable for 10 and 20 nanometer resolutions.

Revised Static Friction for D11 motor from 0.5N to 1.0N, page 23.

Page 29, Changed the following sentence from “These factory settings only allow for a minimum of 3mm (0.12”) before the carriage contacts the end stop.” to “These factory settings only allow for a minimum of 1.5mm (0.06”) before the carriage contacts the end stop.”

Page 9, added encoder option E5 to Order Number Nomenclature section.

Revision 7

Add Compax3 option.

Add MX80L EC declaration.

Revision 8

Add warning for maximum operating voltage for Compax3.

Chapter 1 - Introduction

Product Description

MX80L Positioner

Although the MX80L is small in size and weight, it is large on performance and reliability. All key components are integral to the unit - residing within the body of the stage to provide a clean looking, reliable, unobstructed package. At the heart of the MX80L is an innovative non-contact linear servo motor (patent pending). This direct drive motor has been optimized for force, speed, and acceleration, to deliver outstanding performance and response. A high precision non-contact linear encoder provides sub-micron resolution and repeatability. Selectable resolutions range from 10 nanometers to 5 microns. Precision ground "zero cage creep" crossed roller bearing sets provide extremely smooth - precise linear translation. Travel limit and home sensors are conveniently designed into the unit for easy adjustment over the entire travel of the stage. Although there are no moving cables, 1 or 3 meters of hi-flex cabling depending on configuration option is included and wired directly into the units. This hi-flex cabling addresses cable flexing concerns associated with the second or third axis in multi-axis system.

Unpacking



Unpacking

Carefully remove the positioner from the shipping container and inspect the unit for any evidence of shipping damage. Report any damage immediately to your local authorized distributor. Please save the shipping container for damage inspection or future transportation.

Incorrect handling of the positioner may adversely affect the performance of the unit in its application. Please observe the following guidelines for handling and mounting of your new positioner.

- DO NOT allow the positioner to drop onto the mounting surface. Dropping the positioner can generate impact loads that may result in flat spots on bearing surfaces or misalignment of drive components.
- DO NOT drill holes into the positioner. Drilling holes into the positioner can generate particles and machining forces that may effect the operation of the positioner. Daedal will drill holes if necessary; contact your local authorized distributor.
- DO NOT subject the unit to impact loads such as hammering, riveting, etc. Impacts loads generated by hammering or riveting may result in flat spots on bearing surfaces or misalignment of drive components.
- DO NOT lift the positioner by cables or cable management system. Lifting positioner by cables or cable management system may effect electrical connections and/or cable management assembly. The unit should be lifted by the base structure only.
- DO NOT expose positioner to mist, spray or submersion in liquids.
- DO NOT disassemble positioner. Unauthorized adjustments may alter the positioner's specifications and void the product warranty.

Return Information

Returns

All returns must reference a "Return Material Authorization" (RMA) number. Please call your local authorized distributor or Daedal Customer Service Department at 800-245-6903 to obtain a "RMA" number. See Daedal Catalog #8083/USA, for additional information on returns and warranty.

Repair Information

Out-of-Warranty Repair

Our Customer Service Department repairs Out-of-Warranty products. All returns must reference a "RMA" number. Please call your local authorized distributor or Daedal Customer Service Department at 800-245-6903 to obtain a "RMA" number. You will be notified of any cost prior to making the repair.

Warnings and Precautions



Hot Surfaces

DO NOT touch linear motor coils located in the base of the MX80, (see page 8, *Assembly Diagram*, for component location), after high duty operation. Motor temperature may approach 125 C. The unit itself may become warm or hot to the touch.



Electrical Shock

DO NOT take apart or touch any internal components of the positioner while unit is plugged into an electrical outlet. SHUT OFF power before replacing components to avoid electrical shock.



High Magnetic Field

Unit may be HAZARDOUS to people with Pace Makers or any other 'magnetically-sensitive' medical devices. Unit may have an effect on 'magnetically-sensitive' applications.



Ferrous Materials

The positioner's open design WILL ATTRACT ferrous materials. The customer must take additional precautions in these applications to keep positioner free of these highly magnetic particles.



Vertical Operation

The MX80L is NOT recommended for vertical operation unless it is configured with the pneumatic assist option. If the pneumatic assist is not used, the carriage and customer's load will fall in power loss situations potentially causing product or load damage or personal injury.



General Safety

Because linear motors can accelerate up to 5 g's, and sometimes positioners move without warning, keep all personnel away from dynamic travel range of positioner.

Specification Conditions

Specifications Are Temperature Dependent

Catalog specifications are obtained and measured at 20 Degrees C. Specifications at any other temperature may deviate from catalog specifications. Minimum to maximum continuous operating temperature range (with NO guarantee of any specification except motion) of a standard unit before failure is 5 - 40 degrees C.

Specifications Are Mounting Surface Dependent

Catalog specifications are obtained and measured when the positioner is fully supported, bolted down, and is mounted to a work surface that has a maximum flatness error of:

- Standard Grade: 0.003mm/300mm (0.0001"/ft)
- Precision Grade: 0.001mm/300mm (0.00004"/ft)

Table will operate with work surface 0.100mm/300mm but performance specifications will be significantly effected.

Specifications Are Point of Measurement Dependent

Catalog specifications and specifications in this manual are measured from the center of the carriage, 38 mm above the carriage surface. All measurements taken at any other location may deviate from these values.

Assembly Diagram

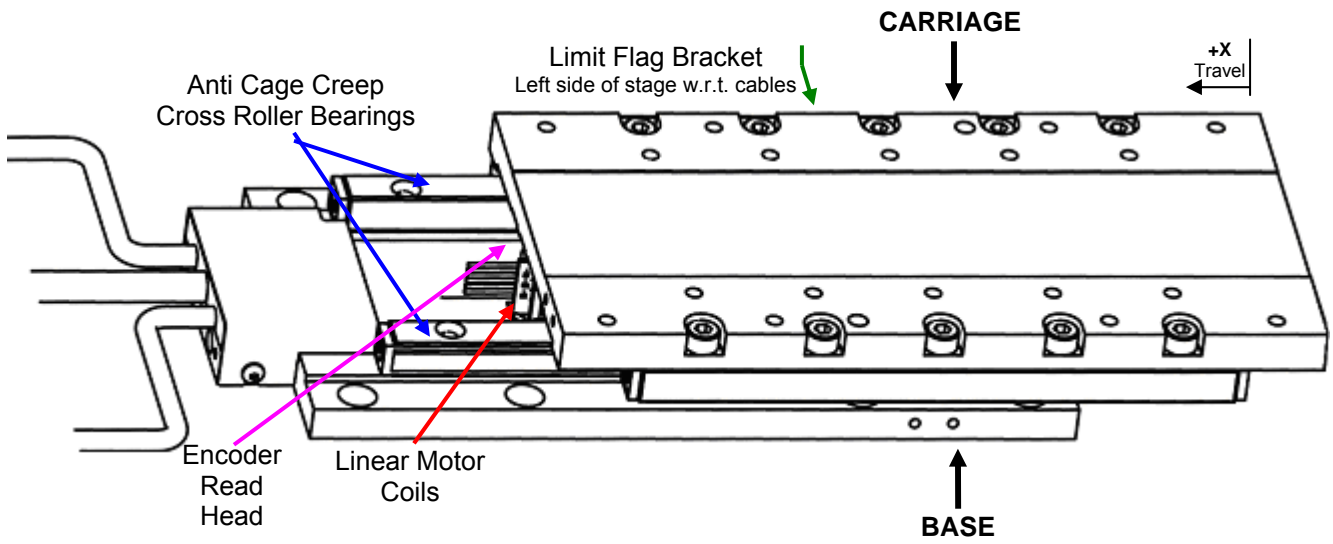

Chapter 2 – MX80L Series Table Specifications

Order Number Nomenclature

	①	②	③	④	⑤	⑥	⑦	⑧	⑨	⑩	⑪	⑫	⑬	⑭	
Order Example:	MX80L	T02	M	P	-D11	H3	L2	CM05	Z3	E8	R1	A25	X1	S1	
① Series	MX80L					⑨ Z Channel Location									
							Z1	None							
							Z3	Center Position							
② Travel – mm						⑩ Digital Linear Encoder Option									
T01	25						E1	None							
T02	50						E2	1.0 µm Resolution							
T03	100						E3	0.5 µm Resolution							
T04	150						E4	0.1 µm Resolution							
T05	200						E5	5.0 µm Resolution							
							E7	Sine output encoder							
③ Mounting							E8	0.02 µm Resolution (20 nanometer)							
M	Metric						E9	0.01 µm Resolution (10 nanometer)							
④ Grade						⑪ Environmental									
S	Standard						R1	Standard Finish (black anodized)							
P	Precision (not available with T05 Travel option)						R2	Cleanroom Prep							
⑤ Drive Type							R10	Low ESD Finish							
D1	Free Travel (No Motor)						R20	Low ESD Finish & Cleanroom Prep							
D11	4 Pole (25 & 50 mm travel only)					⑫ Digital Drive									
D13	8 Pole (100, 150 & 200 mm travel only)						A1	No Drive							
⑥ Home Sensor							A20	ViX250-AH (force mode)							
H1	None-Free Travel (only)						A21	ViX250-AH (velocity mode)							
H2	N.C. Current Sinking						A22	ViX250-AH (step/direction mode)							
H3	N.O. Current Sinking						A25	ViX250-IH Drive/Controller							
⑦ Limit Sensor						⑬ Other Options									
L1	None-Free Travel (only)						X1	None							
L2	N.C. Current Sinking						X2	Z-axis Pneumatic Counter Balance*							
L3	N.O. Current Sinking						* Not available with T05 Travel.								
⑧ Cable Options						⑭ Axis Designator									
CM03	No Cables – Free Travel						S1	None (single-axis)							
CM04	High-Flex Cables w/ViX Connector (1 meter)						S2	X-axis base unit (cables @ 12 o'clock)							
CM05	High-Flex Cables w/ViX Connector (3 meter)						S3	Y-axis 60 arc-sec (cables @ 3 o'clock)							
CM06	High-Flex Cables w/ViX Connector, no limit/home cable (1 meter)						S4	Y-axis 60 arc-sec (cables @ 9 o'clock)							
CM07	High-Flex Cables w/ViX Connector, no limit/home cable (3 meter)						S5	Y-axis 15 arc-sec (cables @ 3 o'clock)							
CM08	High-Flex Cables w/Compax3 Connector (1 meter)						S6	Y-axis 15 arc-sec (cables @ 9 o'clock)							
CM09	High-Flex Cables w/Compax3 Connector (3 meter)														
CM10	High-Flex Cables w/Compax3 Connector, no limit/home cable (1 meter)														
CM11	High-Flex Cables w/Compax3 Connector, no limit/home cable (3 meter)														

Dimensional Drawings

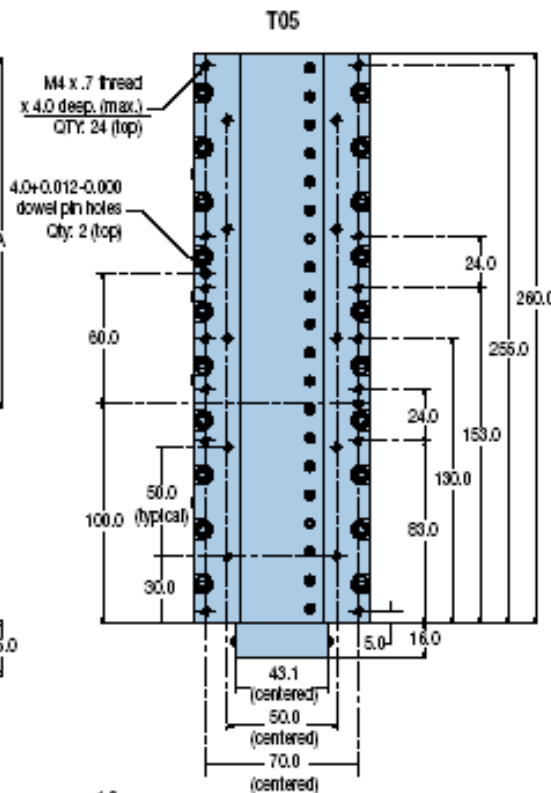
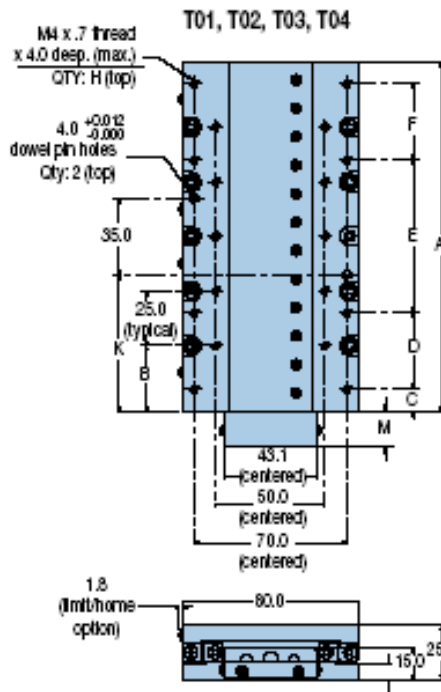

Dimensions (mm)

Z-axis

Travel	Dim Z
25	166
50	166
100	251
150	326
200	-

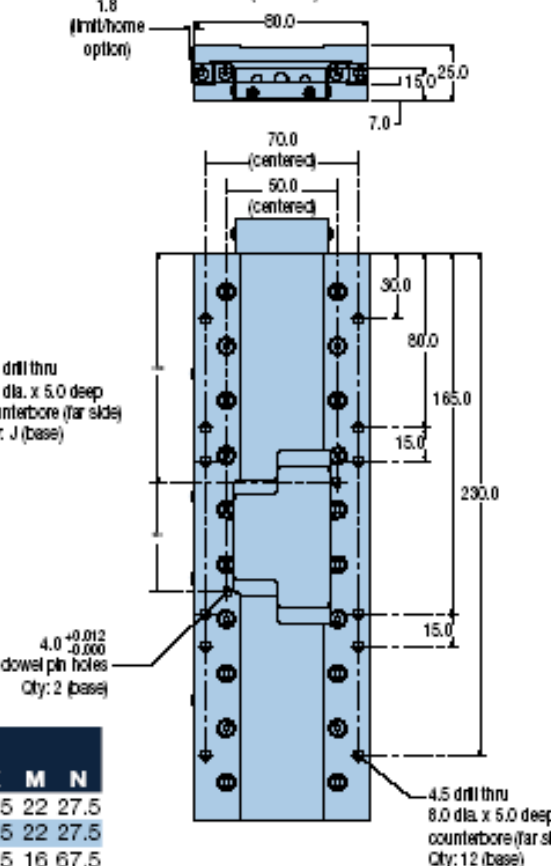
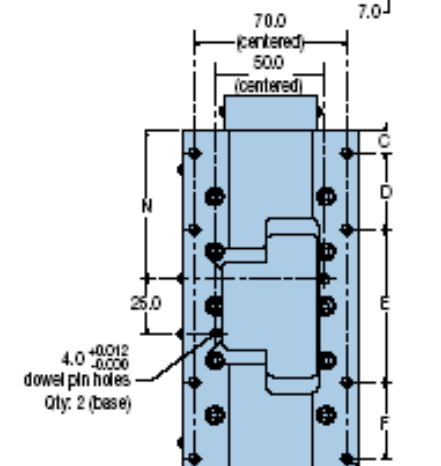

Pneumatic Vertical Axis Counter Balance

Travel	Dim X
25	156.6
50	156.6
100	230.6
150	310.6
200	-

Dimensions (mm)											
Travel	A	B	C	D	E	F	H	J	K	M	N
25	80	15	5	70	-	-	10	4	22.5	22	27.5
50	80	15	5	70	-	-	10	4	22.5	22	27.5
100	160	30	10	35	70	35	18	8	62.5	16	67.5
150	210	30	5	65	70	65	22	8	87.5	16	92.5

Z-axis configuration with counter balance (not available on 200mm Travel)

25 and 50mm travel

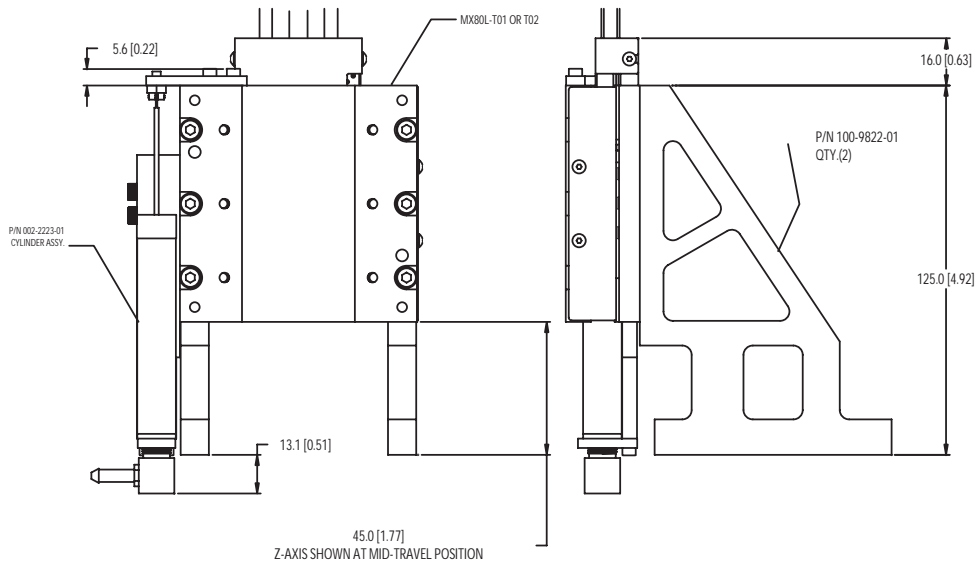

100mm travel

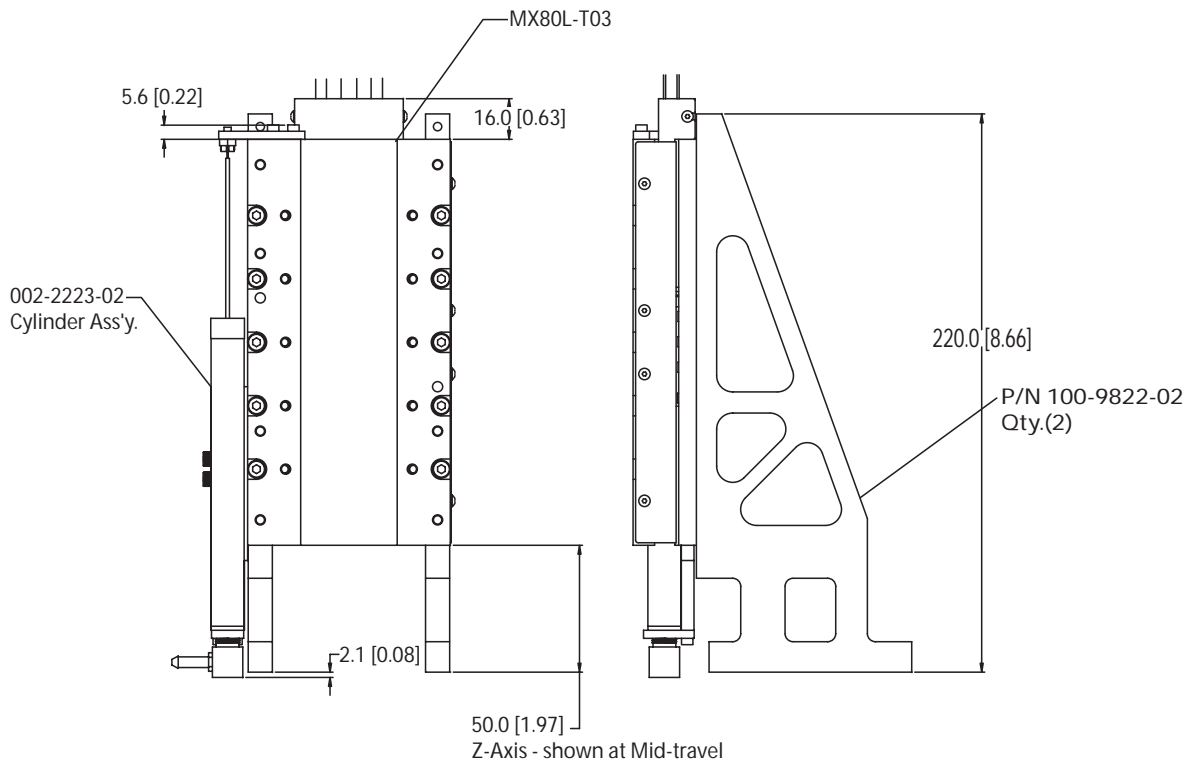

150mm travel

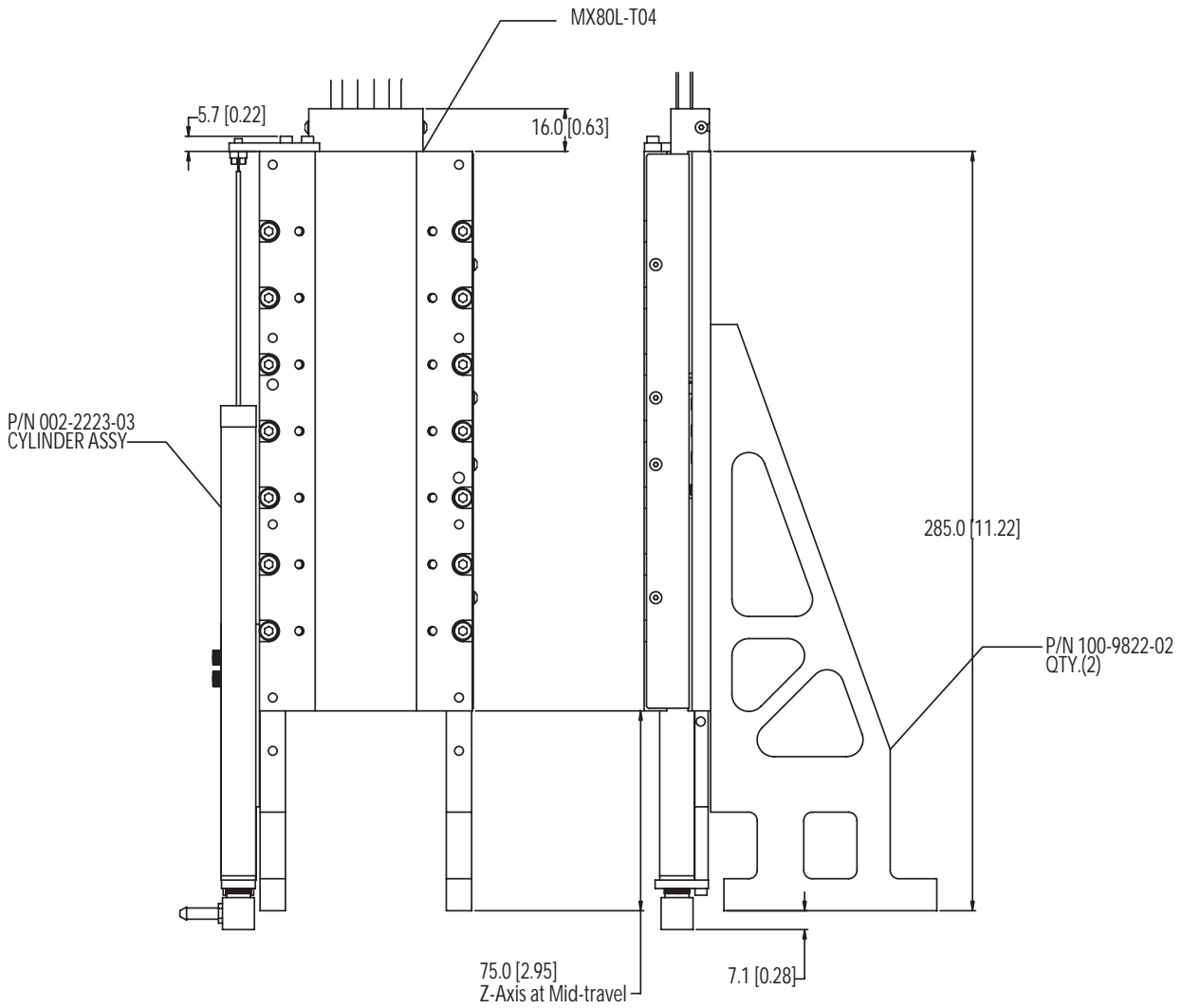

General Table Specifications

		MX80LP Precision Grade				MX80LS Standard Grade				
Travel (mm)		25	50	100	150	25	50	100	150	200
Normal Load Capacity	kg (lb)	8 (18)	8 (18)	8 (18)	8 (18)	8 (18)	8 (18)	8 (18)	8 (18)	8 (18)
Maximum Acceleration	in/sec ²	1544	1544	1544	1158	1930	1930	1930	1544	1175
Maximum Velocity										
5.0 µm		1100	1500	2000	2000	1100	1500	2000	2000	2000
1.0 µm		1100	1500	2000	2000	1100	1500	2000	2000	2000
0.5 µm	mm/sec ²	1100	1500	1500	1500	1100	1500	1500	1500	1500
0.1 µm		300	300	300	300	300	300	300	300	300
0.02 µm		60	60	60	60	60	60	60	60	60
0.01 µm		30	30	30	30	30	30	30	30	30
Peak Force	N (lb)	12 (2.7)	12 (2.7)	24 (5.4)	24 (5.4)	12 (2.7)	12 (2.7)	24 (5.4)	24 (5.4)	24 (5.4)
Continuous Force	N (lb)	4 (0.9)	4 (0.9)	8 (1.8)	8 (1.8)	4 (0.9)	4 (0.9)	8 (1.8)	8 (1.8)	8 (1.8)
Duty Cycle	%	100	100	100	100	100	100	100	100	100
Straightness & Flatness	µm	4	4	5	6	6	6	10	12	14
Positional Accuracy*										
5.0 µm		13	14	15	15	25	30	35	35	35
1.0 µm		5	6	7	7	15	20	25	25	25
0.5 µm	µm	4	5	6	6	12	15	20	20	20
0.1 µm		3	4	5	5	12	15	20	20	20
0.02 µm		3	4	5	5	12	15	20	20	20
0.01 µm		3	4	5	5	12	15	20	20	20
Bi-directional Repeatability*										
5.0 µm		±10.0	±10.0	±10.0	±10.0	±10.0	±10.0	±10.0	±10.0	±10.0
1.0 µm		±2.0	±2.0	±2.0	±2.0	±2.0	±2.0	±2.0	±2.0	±2.0
0.5 µm	µm	±1.0	±1.0	±1.0	±1.0	±1.0	±1.0	±1.0	±1.0	±1.0
0.1 µm		±0.5	±0.5	±0.5	±0.5	±0.5	±0.5	±0.5	±0.5	±0.7
0.02 µm		±0.4	±0.4	±0.4	±0.4	±0.4	±0.4	±0.4	±0.4	±0.5
0.01 µm		±0.4	±0.4	±0.4	±0.4	±0.4	±0.4	±0.4	±0.4	±0.5
Unit Mass	g	590	590	1027	1345	475	475	875	1125	1370
Carriage Mass (unloaded)	g	282	282	509	676	213	213	405	537	695

* Notes:

- (1) Measured at the carriage center, 35 mm above the mounting surface @ 20 °C with no load. Unit bolted to granite surface, flat to within 1micron/300 mm.
- (2) Total accuracy and bi-directional repeatability over full travel (peak to peak).
- (3) Precision grade with slope correction value provided. Consult factory if better accuracy is required.

(1) Total accuracy and bi-directional repeatability over full travel (peak to peak).

Test Methodology

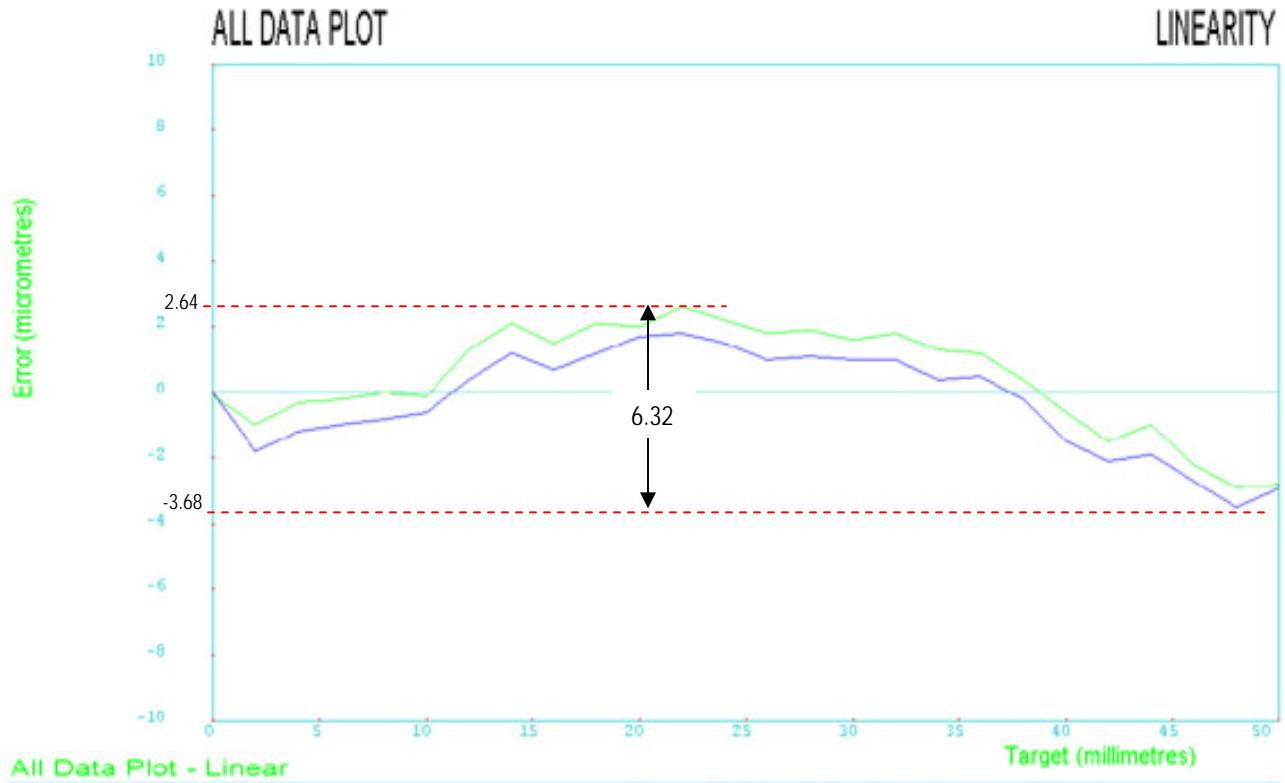

Published accuracy and repeatability specifications are subject to the testing methodology. Daedal's methodology provides specifications over the entire table travel regardless of start or finish position. The accuracy and repeatability specifications are based on the peak to peak error measured by a laser interferometer and prism located at 38mm above the center of the table. This type of measurement sums the X, Y, Z, roll, pitch, and yaw errors. Temperature deviations from test condition may cause deviations in straightness, flatness, accuracy, and repeatability from catalog specifications. Tests are performed with the table mounted to a granite table, unloaded at 20° C.

In this example, the accuracy of an MX80L-T02 ranges from -3.68 microns to 2.64 microns. This table would have its accuracy specified as 6.32 micron since the worst case would be starting at one extreme and traveling to the other.

MX80L Series Technical Data

The useful life of a linear table at full catalog specifications is dependent on the forces acting upon it. These forces include both static components resulting from payload weight, and dynamic components due to acceleration/deceleration of the load. In multi-axes applications, the primary positioner at the bottom of the stack usually establishes the load limits for the combined axes. When determining load/life, it is critical to include the weight of all positioning elements that contribute to the load supported by the primary axis. The life/load charts are used to establish the table life relative to the applied loads.

Life-Load Curve All Travels

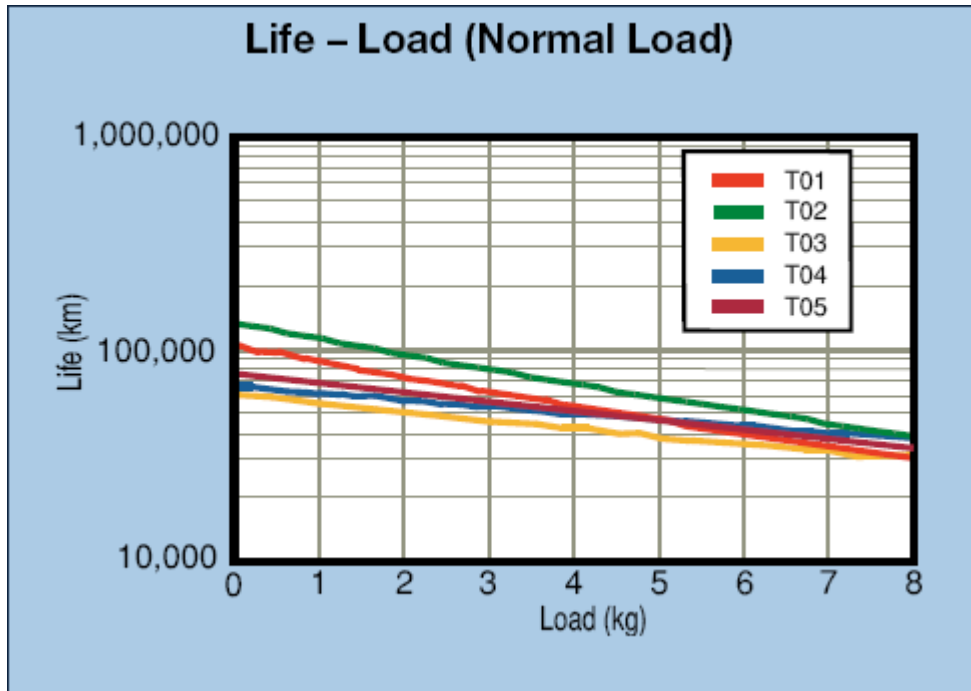

Moment Load – Life Curves

The effect of moment loading on the bearing life is dependent upon load and lever arm. The lever arm in this case is measured from the center of the surface of the table to the point where the load is applied. For dynamic loading, use the distance from the center of the table to the center of mass of the load. The Life-Load charts show curves for various lever arm lengths (units in [mm]). Note Pitch moments and Yaw moments use the same curves.

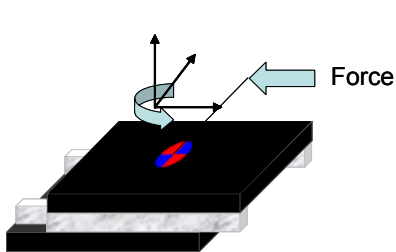

Yaw Moment Loading

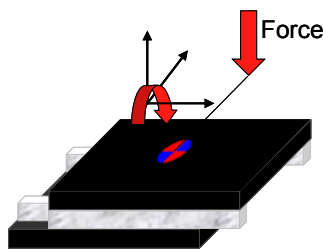

Roll Moment Loading

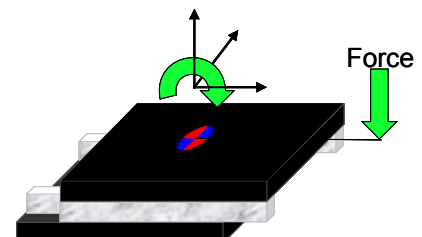

Pitch Moment Loading

[T01] Travel Moment Life – Load Charts

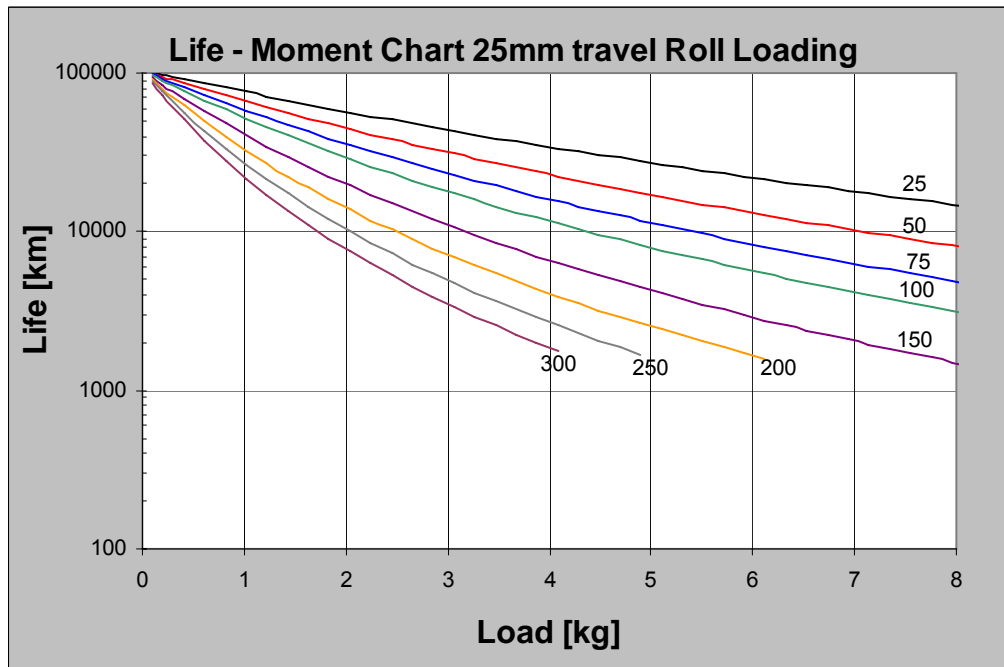
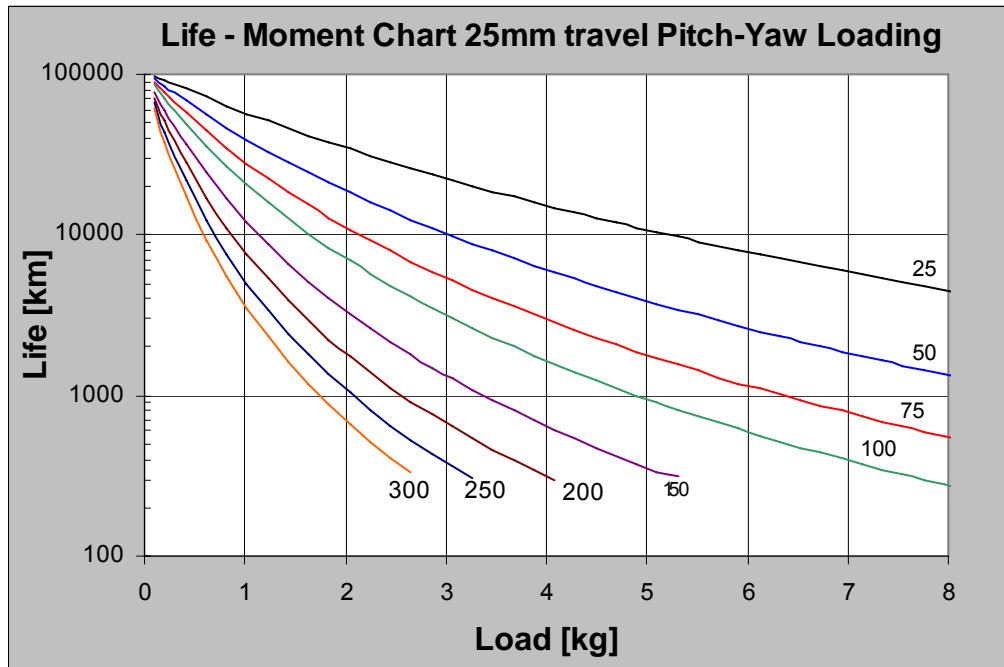

[T02] Travel Moment Life – Load Charts

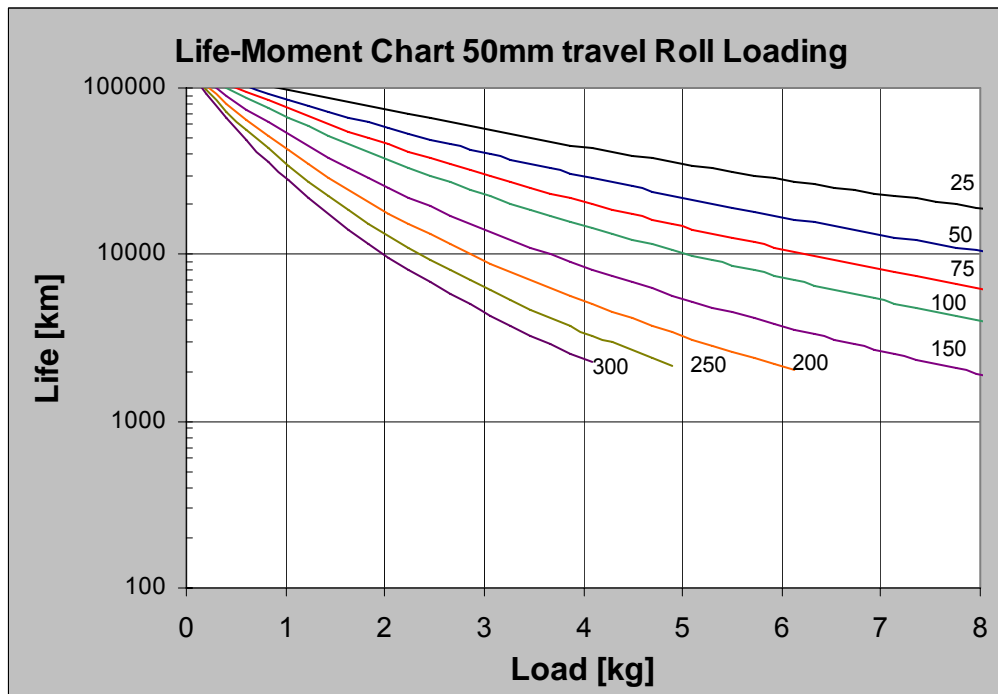
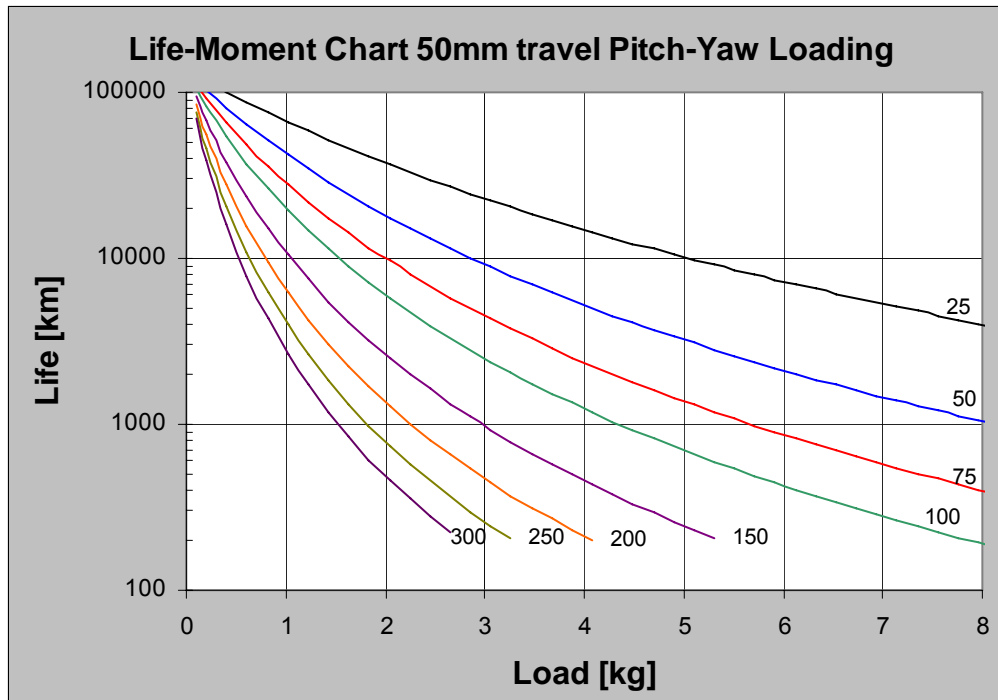

[T03] Travel Moment Life – Load Charts

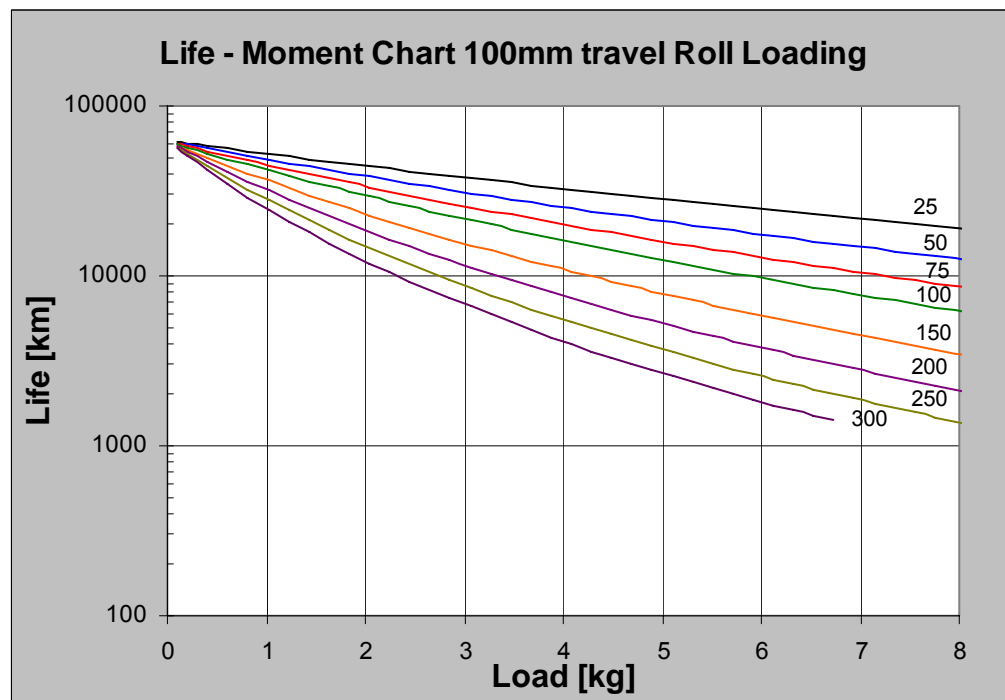
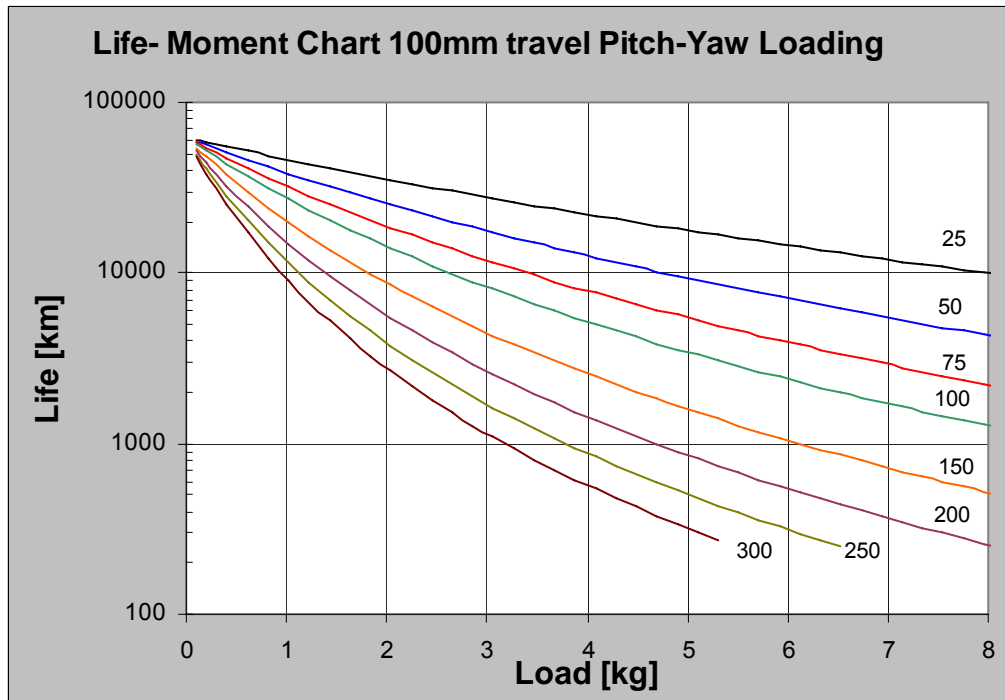

[T04] Travel Moment Life – Load Charts

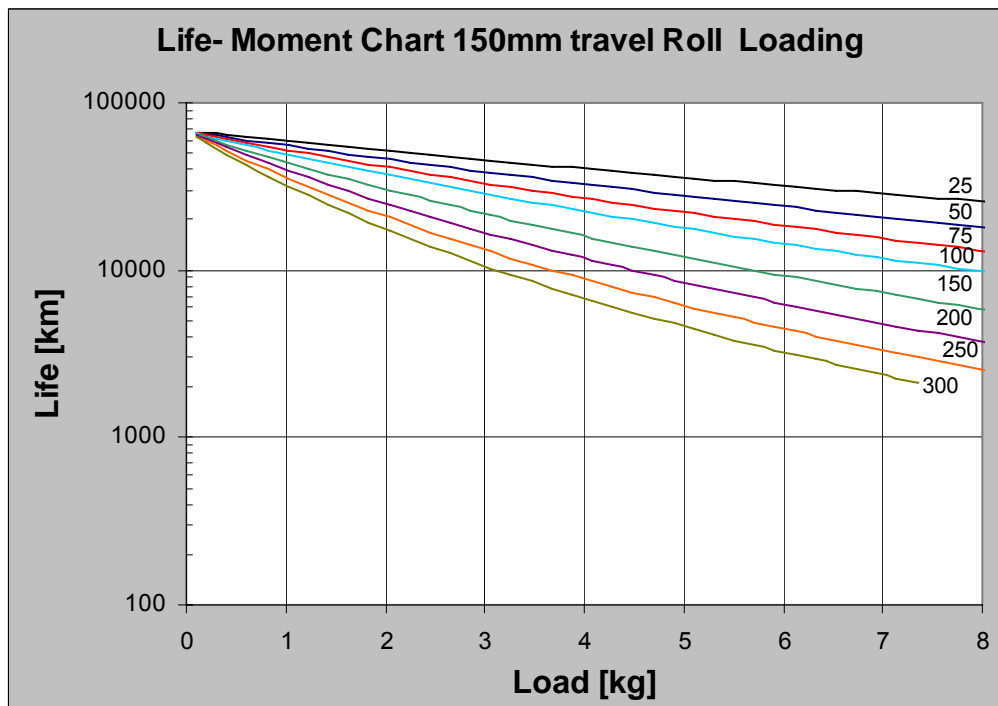
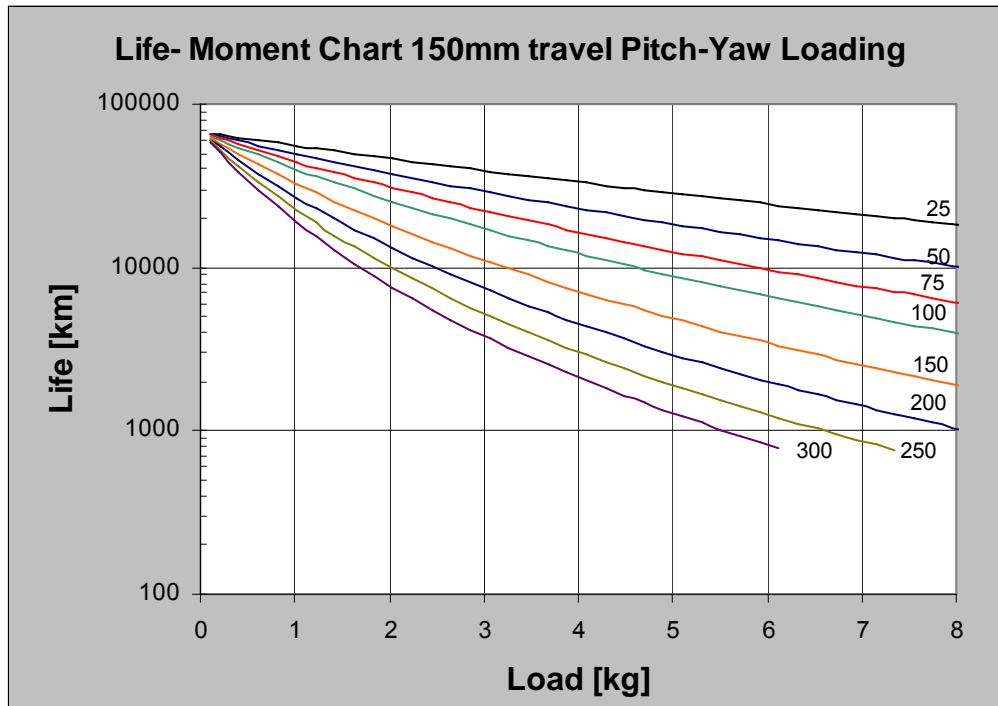

Linear Motion Guide Bearing Life/Load Computation

To predict the travel life of the MX80L cross roller bearings under a moment load use the curve with the corresponding lever arm and given load. Factor in dynamic as well as static loads. For compound loading (multiple moments) use an “effective lever arm of 2x actual lever arm.

Example:

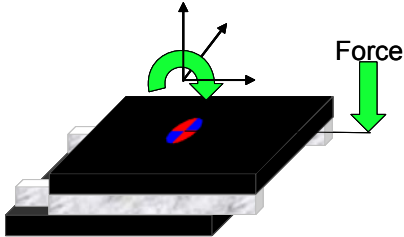

Given a MX80L-T02 with a 2 kg load mounted 35 mm off of the end of the carriage in line with the travel path. The lever arm is 35 mm + 40 mm (center of table to edge) = 75 mm
 This loading produces a pitch moment. Therefore, using the Pitch curve for the 50mm travel, draw a vertical line up from the x-axis at the 2 kg load point until it intersects the 75 curve. The point of intersect is the predicted bearing life of the table. In this example the life is 10,000 km of travel

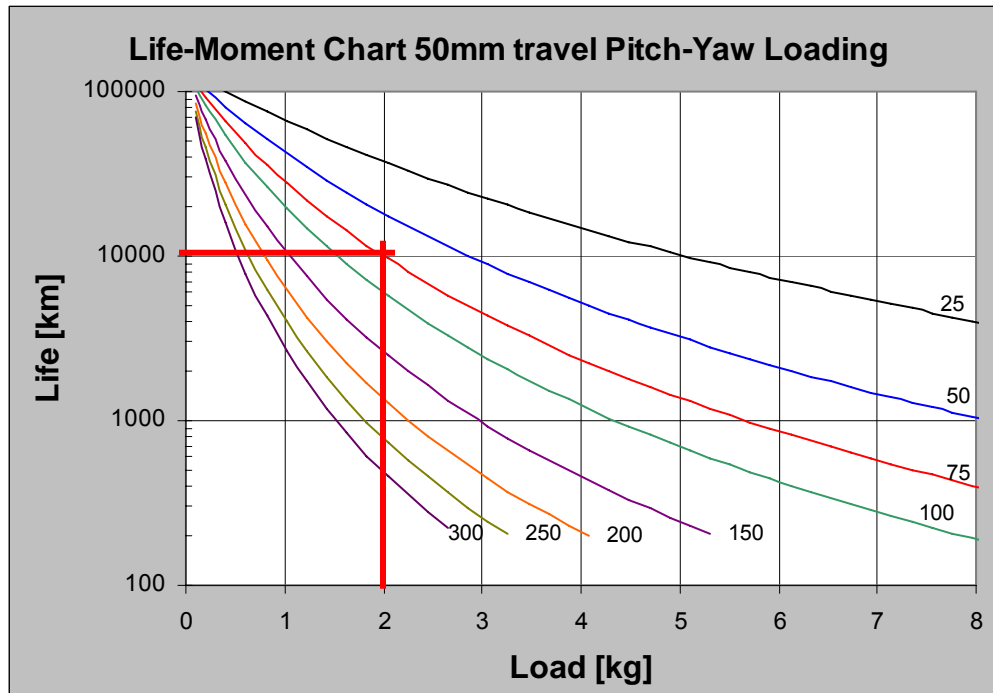

MX80L Series Technical Data

Force/Speed Chart

The Force/Speed Charts for the MX80L are shown for all available travels. In the maximum allowable travel range the motor force is the same for 80 and 48 VDC bus voltage. See Electrical Specifications for motor parameters. Performance based on table mounted to 200mmx150mmx20mm Aluminum plate.

Curves shown include friction and viscous damping values of table. Peak speed is limited by travel length for 25mm [T01] and 50mm [T02] travel lengths.

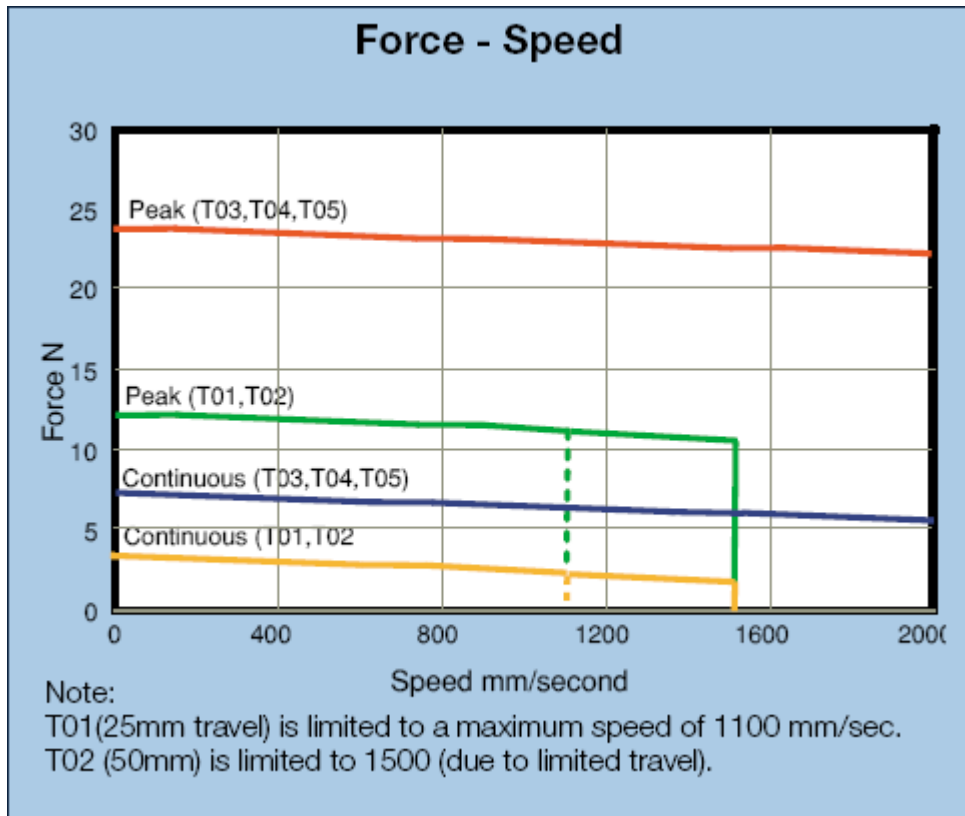

Blank Page

Electrical Specifications

Specifications for both the 4 pole **D11** and 8 pole **D13** linear servo motors

Parameter:	Symbol:	Units:	25 & 50 mm D11	100 mm D13	150 mm D13
Stall Force Continuous [1]	Fcs	N	4.0	8.0	8.0
Stall Current Continuous [1, 4, 8]	Ics(sine)	Amps Peak	1.13	2.26	2.26
Stall Current Continuous [1, 7]	Ics(trap)	Amps DC	0.92	1.84	1.84
Stall Current Continuous [1]	Ics(RMS)	Amps RMS	0.8	1.6	1.6
Peak Force [6]	Fpk	N	12	24	24
Peak Current [4, 6, 8]	Ipk(sine)	Amps Peak	3.2	6.4	6.4
Peak Current [6, 7]	Ipk(trap)	Amps DC	2.8	5.5	5.5
Peak Current [6]	Ipk(RMS)	Amps RMS	2.4	4.8	4.8
Voltage Constant [3, 4]	Ke	Volts/m/s	4.5	4.5	4.5
Voltage Constant [3]	Ke (RMS)	Volts RMS/m/s	3.2	3.2	3.2
Force Constant [9]	Kf(sine)	N/Amps Peak	3.90	3.90	3.90
Force Constant [3, 4]	Kf(trap)	N/Amps DC	4.50	4.50	4.50
Force Constant [3]	Kf(RMS)	N/Amps RMS	5.51	5.51	5.51
Resistance [3]	R	Ohms	8.8	4.3	4.3
Inductance [5]	L	mH	2.4	1.6	1.6
Maximum Bus Voltage	Vm	Volts DC	80	80	80
Thermal Resistance Wind-Amb	Rth w-a	C/watt	6.8400	3.4000	3.4200
Motor Constant	Km	N/sqrt(watt)	1.46	2.06	2.06
Viscous Damping	B	N/m/s	0.500	0.5	0.800
Static Friction [13]	Fs	N	1.0	1.0	1.0
Motor Thermal Time Constant	Tau_th	minutes	0.8	0.8	0.8
Winding Thermal Time Const	Tau_wnd	minutes	0.5	0.5	0.5
Intermittent Force Duration [10]	T_2x	seconds	8.0	10.0	10.0
Peak Force Duration [11]	T_3x	seconds	1.2	2.3	2.3
Electrical Pitch [12]	Pe	mm	13	13	13
Rated Winding Temperature	RT	C	95	95	95
Rated Ambient Temperature	AT	C	20	20	20
Winding Class			H	H	H

1. @ 25° C ambient, 125C Winding Temperature with the table mounted to a 200mm x 150mm x 20mm aluminum plate
2. Measured with a 0.33 mm gap
3. Measured Line to Line +/-10%
4. Value is measured peak of sine
5. +/-30% Line to Line, inductance bridge measurement @1Khz
6. Initial winding temperature must be 60 C or less before Peak Current is applied
7. DC current through a pair of motor phases of a trapezoidal (six state) commutated
8. Peak of the sinusoidal current in any phase for a sinusoidal commutated motor
9. Total motor force per peak of the sinusoidal amps measured in any phase, +/-10%
10. Maximum time duration with 2 times rated current applied with initial winding temp at 60 C
11. Maximum time duration with 3 times rated current applied with initial winding temp at 60 C
12. The Distance from the leading edge of the north pole to the leading edge of the next north pole
13. Average friction over total table travel

Clean Room Preparation

There is no clean room 'rating' for motion control products just individual compatibility with class of clean rooms. The compatibility is also dependant on measurement location. A point directly below a component may have a different particle count than at a side location. In an effort to clarify the class of clean room that our products can be used in with out affecting the overall rating of the clean room, Daedal provides a Clean Room Class Compatibility chart for product intended for use in such environments. Due to the moving magnet design of the MX80L, minimal particle generation occurs during operation. MX80L tables with clean room preparation were tested in Daedal's vertical laminar flow work station which utilizes ULPA filters to produce an environment having a cleanliness of class 10 prior to testing. Tables were tested in a variety of orientations with sampling both below the table and at the carriage mounting surface with a particle counter capable of measuring 0.3 μm diameter and larger particles. Based on results from testing following the 209E Federal Standard, the following chart shows the expected clean room compatibility of the MX80L with Class 10 clean room prep. Consult factory for details on test methodology and results.

MX80L Clean Room Class Compatibility*				
Velocity [mm/sec]	25 & 50 mm Travel		100 & 150 mm Travel	
	4.5" below	At stage top	4.5" below	At stage top
1	1	1	5	1
5	1	1	5	1
10	1	1	5	1
25	1	1	5	1
50	1	1	10	5
100	1	1	10	5
250	1	5	25	10
500	10	5	50	10
1000	25	10	50	25
1500	n/a	25	100	25
2000	n/a	n/a	100	25

* Compatibility is defined as not affecting the clean room class rating with the addition of this product for classes shown. For example a MX80L with 50mm travel with a velocity of 500mm/sec will not effect a class 10 clean room or higher. The Class 1 rating in the table refers to class 1 levels of 0.3μ and larger particles detected in Daedal's Class 10 chamber. For complete class 1 compatibility, the particle count for the 0.1 and 0.2μ particles would also need to be taken into consideration.

Standard Clean Room Preparation

- Stringent cleaning and handling measures
- Clean room rated lubricant
- Reduce force specification by 25%

Encoder Specifications

Description	Specification
Input Power	5 VDC +/-5% 150 to 220 mA depending on encoder resolution
Output (Incremental) E2, E3, E4, E5, E7, E8, E9	Square wave differential line driver (EIA RS422) 2 channels A and B in quadrature (90°) phase shift.
Reference (Z Channel)	Synchronized pulse, duration equal to one resolution bit. Repeatability of position is unidirectional moving toward positive direction and is equal to table repeatability specifications.
Maximum Speed	5.0 micron resolution = 2.0 meters/sec (limited by table) 1.0 micron resolution = 2.0 meters/sec (limited by table) 0.5 micron resolution = 1.5 meters/sec 0.1 micron resolution = 0.3 meters/sec 20 nanometer resolution = 0.06 meters/sec 10 nanometer resolution = 0.03 meters/sec

Hall Effect Specification

Description	Specifications
Input Power	+5 VDC, 30 mA
Output	Open collector, Current Sinking, 20 mA Max

Limit and Home Sensor Specifications

Description	Specification
Input Power	+5 VDC 60 mA (power from encoder, no additional connection needed)
Output	Output form is selectable with product: - Normally Closed Current Sinking - Normally Open Current Sinking NPN open collector +5 to +24 VDC All types Sink maximum of 50 mA
Repeatability	Home Sensor: +/- 5 μ m (unidirectional) with 1.0 micron or better encoder NOTE: Repeatability using z-channel refers to encoder specifications

Low ESD Specifications

The low ESD (ElectroStatic Discharge) option refers to either an electroless nickel coating on standard grade tables or an Armoloy® coating on precision grade tables that provides a very low resistance path to ground from all surfaces of the MX80.

Drive Specifications

Refer to Specifications provided in the ViX Manual.

Standard Cabling and Wiring Diagrams

Connector Pin Out and Extension Cable Wire Color Codes for the 5, 1, 0.5 and 0.1 micron resolution encoders

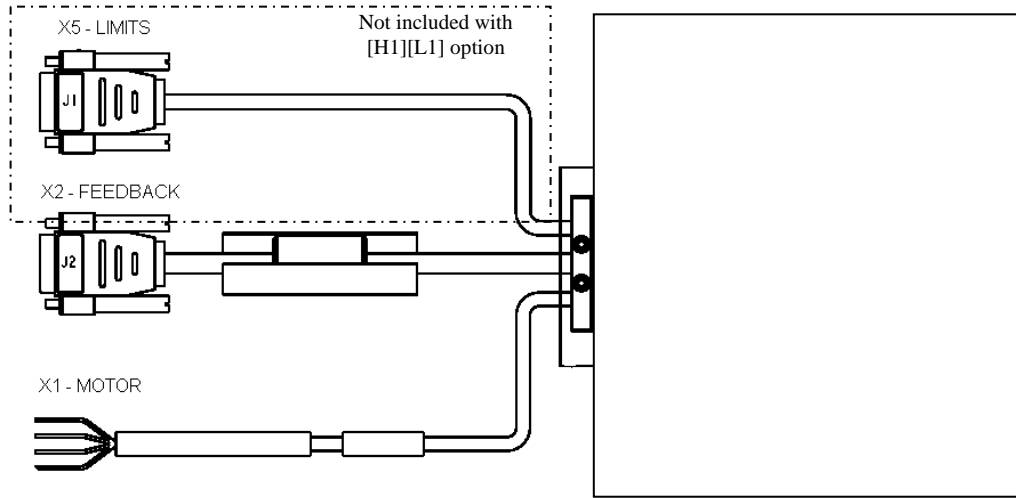

ViX X5 – LIMITS CONNECTOR		
PIN	FUNCTION	WIRE COLOR
1	GND	BLACK
6	+ End of travel	ORANGE
7	- End of travel	BLUE
8	Home	GREEN

ViX X1 – MOTOR LEADS	
WIRE COLOR	DRIVE
RED	U
WHITE	V
BLACK	W
GREEN	GND

ViX X2 – FEEDBACK-HALL CONNECTOR		
PIN	FUNCTION	WIRE COLOR
1	Encoder Z+	ORANGE
2	Encoder Z-	BROWN
3	GND	BLACK & WHITE/GREEN
5	+5V	RED & WHITE/GREEN
6	Temperature-	YELLOW/BLACK
7	Encoder A+	WHITE
8	Encoder A-	YELLOW
9	Hall#1	WHITE/BROWN
10	Temperature+	YELLOW/RED
11	Encoder B-	BLUE
12	Encoder B+	GREEN
13	Hall#2	WHITE/ORANGE
14	Hall#3	WHITE/VIOLET

Note: Tables purchased before June 1, 2009 require an interpolator box and a bypass cable for 10 and 20 nanometer resolutions.

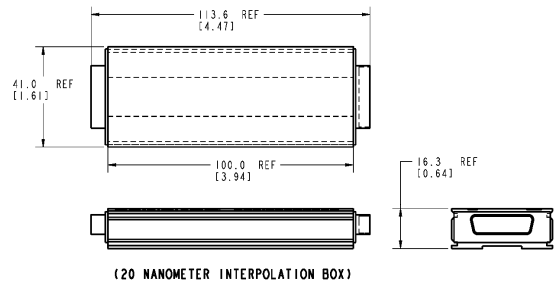

(20 NANOMETER INTERPOLATION BOX)

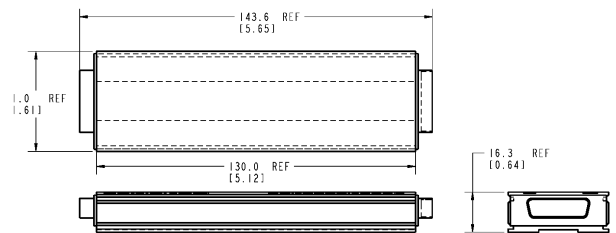

(10 NANOMETER INTERPOLATION BOX)

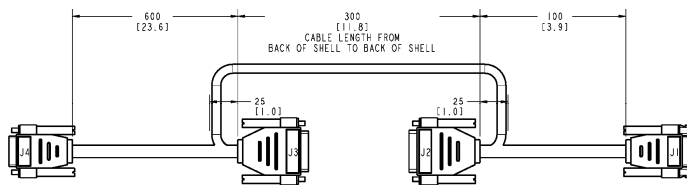

Compax3 Cabling and Wiring Diagrams

Compax3 Connector Pin Out and Extension Cable Wire Color Codes

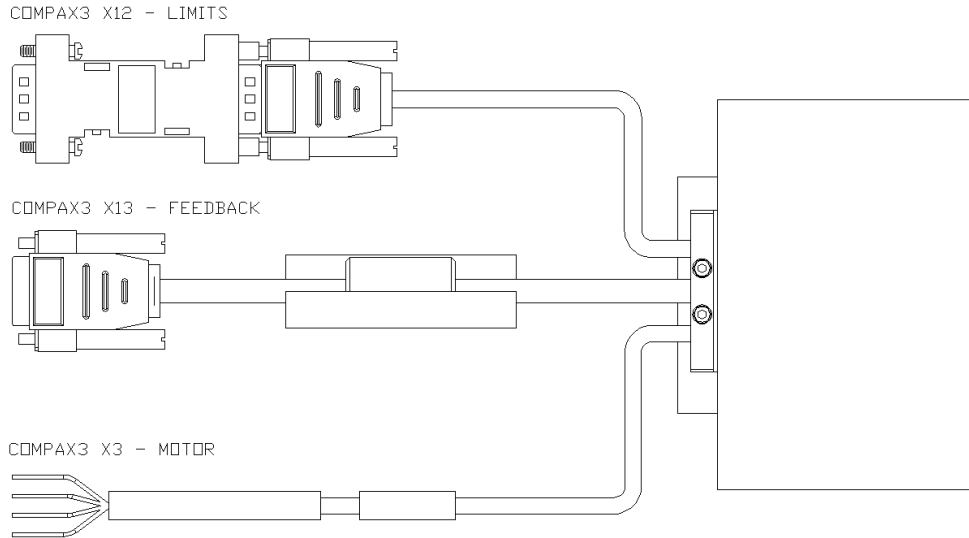

Compax3 X12 – LIMITS CONNECTOR		
PIN	FUNCTION	WIRE COLOR
12	+ End of travel	ORANGE
13	- End of travel	BLUE
14	Home	GREEN
15	GND	BLACK

Compax3 X3 – MOTOR LEADS	
WIRE COLOR	DRIVE
RED	U
WHITE	V
BLACK	W
GREEN	GND

Compax3 X13 – FEEDBACK-HALL CONNECTOR		
PIN	FUNCTION	WIRE COLOR
1	Sense-	WHITE/GREEN
2	Sense+	WHITE/BLUE
3	Hall#1	WHITE/BROWN
4	+5V (Encoder/Hall)	RED
5	+5V	2.2K Ohm to T+ (Pin10)
6	Hall#2	WHITE/ORANGE
7	A-, V ₁ -	YELLOW
8	A+, V ₁ +	WHITE
9	Hall#3	WHITE/VIOLET
10	T+	YELLOW/RED
11	B-, V ₂ -	BLUE
12	B+, V ₂ +	GREEN
13	Z+, V ₀ +	ORANGE
14	Z-, V ₀ -	BROWN
15	GND/T-	BLACK & YELLOW/BLACK



Warning - When using a Compax3 drive the input voltage cannot exceed 56VAC so that the bus voltage does not exceed 80VDC.

Chapter 3 - How to Use the MX80L

Mounting Orientations

The MX80L can be mounted normal, inverted, side or vertically. For vertical (z-axis) mounting the pneumatic counter balance is recommended to compensate for the effect of gravity on the carriage and the load. For all mounting orientations, the cables should be secured as to not interfere with the movement of the carriage and bearings.

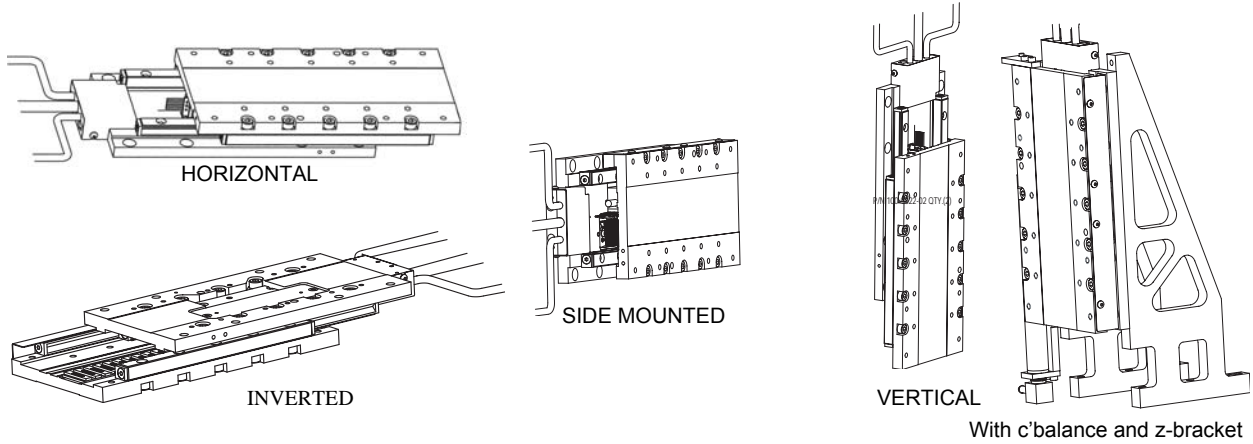

Mounting Surface Requirements

Proper mounting of the MX80L is essential to optimize product performance. All specifications are based on the following conditions:

- The positioner must be bolted down using all counter bored mounting holes provided (4 on T01 & T02, 8 on T03, T04, & T05) using M4 socket head cap screws.

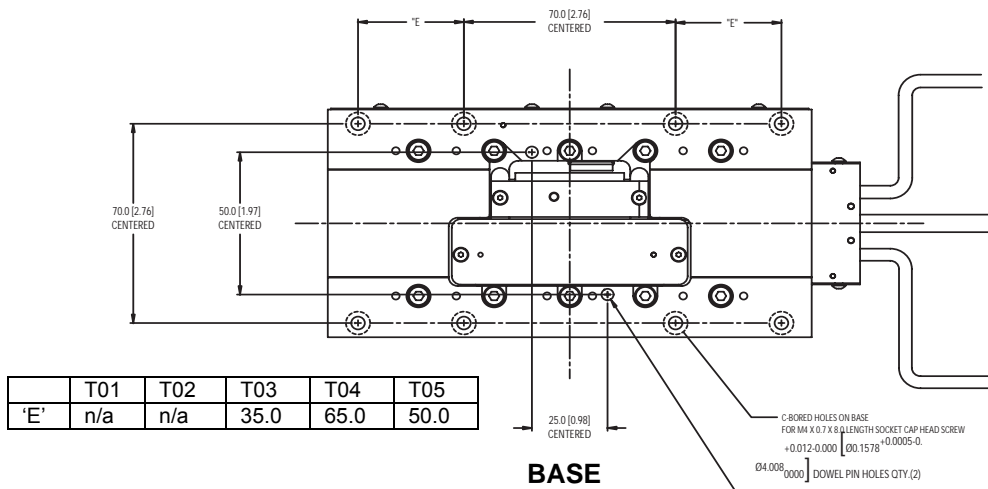

- The positioner must be mounted to a flat, stable surface, with a flatness error less than or equal to 0.025mm/300mm for operation (specifications will be greatly varied from published specification). To meet catalog specifications the surface must have a flatness error less than or equal to 0.003mm/300mm for Standard grade and 0.001mm/300mm for Precision grade.

- Catalog specifications may deviate for positioners mounted to surfaces that do not meet the above conditions.
- If the intended mounting surface cannot meet these specifications a separate rigid mounting plate meeting these specifications should be used to mount to the main structure.
- If mounting conditions require that the table base is overhung, table specifications will not be met over that portion of the table. Additionally, in X-Y Systems the overhung portion of the Y-axis may not meet specifications due to the additional error caused by deflection and non-support of the base. Contact Daedal for guidelines on specifications of overhang applications

Load Mounting Requirements

Dowel holes are included in the carriage of the MX80L for repeatable mounting of loads/fixtures. When bolting payload to carriage take precaution in using bolts M4 with 7mm of engagement as to not damage the table.



Use appropriate length bolt.

The MX80L compact design requires proper sized bolts to be used when mounting payloads to the carriage. Excessive length bolts can damage bearings or pin the table in position.

Limit and Home sensor operation

The MX80L utilizes an innovative method for setting limit and home positions. The magnetic sensors embedded in the base of the MX80L change state based on the limit “flag”. This space saving, compact design consists of three (3) parts; magnetic sensors, limit flag and limit flag bracket. The limit and home magnetic sensors are mounted to a PCB in a fixed position to the base of the unit. The flag bracket is mounted to the left side of the carriage with respect to the cables. The Limit Flag is a pattern of thin magnets which triggers the sensors. This pattern defines whether the switch functions as normally open or normally closed. A limit is normally closed when the switch operates from non-magnet to magnet surfaces. The home switch is normally open when the switch operates from non-magnet to magnet surfaces. To change from normally open to normally closed operation of the sensor the patterns are reversed.

Example of Limit and Home Flag magnets corresponding to possible MX80L Limit Home configurations:

Config	Home	End of Travel	Limit Flag Magnets
H2 L2	Normally Closed	Normally Closed	
H2 L3	Normally Closed	Normally Open	
H3 L2	Normally Open	Normally Closed	
H3 L3	Normally Open	Normally Open	



H1L1 Option Upgrades

- Limits and Homes can not be added to the MX80S table in the field due to the integrated design which encloses the sensor on a printed circuit board in the base. If the magnetic sensor limit and home are desired the unit must be returned to the factory on an RMA.
- To change Limit/Home operation from Normally Open to Normally Closed or from Normally Closed to Normally Open a new limit flag bracket must be purchased, contact factory for proper configuration and part number.
- To adjust the operating position of the limits, limit/home adjustment magnets can be adhered on top of the existing limit flag. These adjustment magnets are included with the unit.
 To change the activation position of the sensors:
 - Determine desired position
 - Cut magnet to proper length
 - Follow Adjusting Limit Flag Procedure to add to the adjustment

Determining Desired Position

The limit sensors are set at the factory for maximum travel. These factory settings only allow for a minimum of 1.5mm (0.06”) before the carriage contacts the end stop. In slow speed applications this may be adequate, however as the top speed of the application increases the required deceleration distance increases. To determine the safe Deceleration Distance the Maximum Speed and the Maximum Obtainable Deceleration Rate must be known or calculated. The maximum speed should be known from your application requirements. Velocity limits should be set in your program or in your amplifier to cause a fault if the speed exceeds this value. The maximum deceleration is a factor of load and available peak force of the table. Using $F = ma$, calculate maximum acceleration and then required deceleration distance. See the following example for calculating maximum deceleration for an application with a payload = 0.25 kg on an MX80-T01 with a maximum speed of 500 mm/s.

Total mass = 0.46 kg (Payload mass = 250 grams + Carriage mass = 213 grams)

Application Speed = 500mm/sec

Available peak force at .25 m/sec = 11.8 N (See Chapter 2, *Force / Speed Curve*)

Maximum Obtainable Deceleration Rate

Thus: $F = ma \rightarrow a = F/m \rightarrow a = 11.8N / 0.46kg \rightarrow \underline{25.6 \text{ m/sec}^2}$

Now, calculate the **Deceleration Distance** for linear deceleration:

First... find the *Deceleration time*:

$Ta = \text{Max Velocity} / \text{Deceleration Rate}$

$Ta = .50 \text{ m/sec} / 25.6 \text{ m/sec}^2 \rightarrow 0.020 \text{ seconds}$

Second... find the **Deceleration Distance**:

$\text{Distance} = ((\text{Max Velocity}) * (Ta)) / 2$

$\text{Distance} = ((500 \text{ mm/sec}) * (0.020)) / 2 \rightarrow \underline{5.0 \text{ mm}}$

This means that both the positive and negative limit switch targets must be moved inward by 5.0 mm. The limit deceleration rate should be set to 25.6 meters/sec². Using the supplied limit flag sheet cut two 5.0mm long strips from the appropriate white or black (depending on configuration) marked Limit/Home Adjustment overlay decal and follow the procedure for changing the limits.

Adjusting the Limit Flag Procedure

The following procedure is to be used for changing the limit flag (switching activation from N.O. to N.C. or vice versa) and adjusting the activation position of the end of travel limits on the MX80: (Images shown are for changing H3L2 to H2L3)

Step 1: Remove power from the unit and allow time for stage base and carriage to reach room temperature

Step 2: Remove the limit flag bracket from the MX80L by removing the button head cap screws (BHCS) that secure the bracket to the side of the carriage.

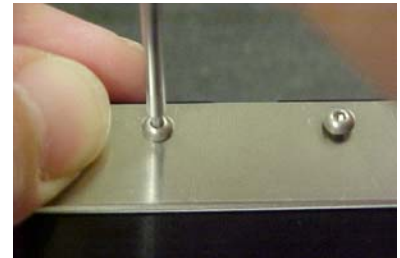

Step 3: Gently slide the bracket from out from under the carriage.

Step 4a: *To adjust limits to increase travel:* With a razor, cut and remove the desired amount of protective sticker and magnet which equals the amount of desired travel increase.



Step 4b: *To adjust limits to reduce travel:* With a razor, cut the clear protective sticker at the end of the magnet that is to be adjusted. Flatten out protective sticker at the cut, this allows a flat surface to adhere additional magnet. Place additional self adhesive magnet (supplied with positioner) at the end of the existing magnet which equals the amount of desired travel reduction. Confirm that there is no gap between the original magnet and the additional magnet just applied. If there is a gap, remove the additional magnet, discard it, and apply a new magnet.



Step 5: Gently slide bracket under carriage. Push up on bracket, insert 0.5mm to 1.0mm shims between bracket and base, insert and tighten BHCS.

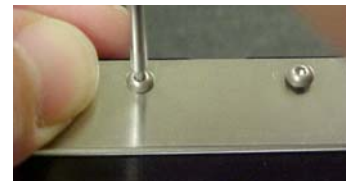

Setting Home Sensor

The MX80L is equipped with a “home” position reference sensor when purchased with Home configuration option [H2] or [H3]. The home sensor is located on the same PCB as the limit sensors and the target is located between the limit targets. The sensor is typically used in conjunction with the encoder ‘Z’ marker. If another home location is desired, the home target can be adjusted by removing the limit flag decal and applying adjustment overlay decals in the desired location.

Z Channel Position Reference

The Z channel is an output on the encoder. Many servo controllers support this input. The Z channel on the MX80L is at mid travel. The Z channel is a unidirectional device. This means that the final homing direction must occur in one direction. The MX80L is set that the final home direction is to be toward the positive end of the table (See Chapter 2, *Dimensional Drawing*, for positive direction definition). The repeatability of the Z channel is equal to the repeatability of the table. Thus the repeatability of the “Z” channel equals:

Encoder Resolution	Z Channel Repeatability
5 micron	+/- 10 micron
1 micron	+/- 2 micron
0.5 micron	+/- 1 micron
0.1 micron	+/- 0.4 micron
0.02 micron	+/- 0.4 micron
0.01 micron	+/- 0.4 micron

NOTE: Home repeatability is also very dependent on controller input speed and homing algorithms. The above repeatability does not include possible controller tolerance. Additionally, to achieve the highest

repeatability the final homing speed must be slow. Slower final speed usually results in higher repeatability.

NOTE: The “Z” channel output is only one resolution count wide. Thus the on-time may be very brief. Due to this some controllers may have difficulty reading the signal. If you are experiencing the positioner not finding the “Z” channel during homing, try reducing final homing speed; also refer to your controller manual for frequency rates of the “Z” channel input.

Grounding / Shielding

All cables are shielded. These shields are to be grounded to a good earth ground. Failure to ground shields properly may cause electrical noise problems. These noise problems may result in positioning errors and possible run away conditions.

The motor cable has an area of the shield exposed to allow a grounding path from shield to drive ground. The Hall/Encoder and Limit/Home cables have the shield carried through the connector hood that is in turn grounded through the drive. MX80L purchased with ViX drives as part of the configurable part number come equipped with p-clips designed for the small OD of the motor cable to allow the cable shield to be grounded to the ViX ground.

Cabling

The MX80L is provided with high flex cabling which is strain relieved at the connection point on the positioner. The Hall/Encoder cable is terminated with a high density 15 pin D-sub connector which is compatible with the ViX drive from Parker. The motor cable is terminated with flying leads which are stripped and tinned and ready for installation into the screw terminals on the ViX drive. For wire color codes and pin outs see tables in electrical section of manual.

The limit/home cable is optional and therefore if not ordered a space will be open in the clamp at the connection point. The limit/home cable is provided with a 15 pin D-sub connector which is compatible with the ViX drive. For wire color codes and pin outs see tables in electrical section of manual.

Recommended bend radius for these cables is 50mm. This radius will provide a minimum of 10 million cycles of the cable. Smaller bend radius will reduce cable life while larger bend radius will increase life.

If the positioner is mounted in a multi-axis configuration special care should be taken in routing and strain relieving the cables so as to prevent flexing of the cable at the connection to the table and where mounted stationary to the structure. Provide sufficient service loop that the cable bends a minimum of 25mm from these end points. It is also recommended to avoid twisting the cable. The cable should be secured in a position which will orient it in a direction that creates a single plane of operation for the cable.

To replace extension cables 1.) Disconnect power to positioner. 2.) Remove two button head screws from side of shield and remove the shield. 3.) Remove the two cap head screws from the strain relief and remove the strain relief. 4.) unplug extension cables. 5.) Reverse steps to reassemble.

Note: When reassembling the strain relief, take care not to pinch any wires and be certain that the exposed braided shield on the cables lies under the strain relief.

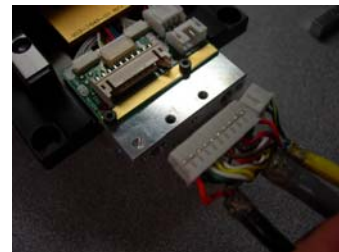

Cable Management

For multi-axis configurations special attention needs to be taken into account for the moving cables on the non-base axis.

TIP: For Multi-axis Configurations.

Consider using the top axis for the highest frequency move in the application. The top axis will have the least amount of weight to move and will reduce the cycles on the cables.

Pneumatic Counterbalance

Cylinder Specification

Description	Specifications
Cylinder Piston Area	0.105 in ²
Cylinder Mounting Torque	Head nut 0.45 – 0.90 Nm (4 – 8 in-lbs)
	Rod End. 0.23 – 0.56 Nm (2 – 5 in-lbs)
Maximum Compressive Rod Force	10 lbs
Allowable Input Pressure	0 – 100 psi
Coefficient of Friction	0.015 (assuming no side load)
Operating Temperature	-20 – 175° F

Counter Balance Force

For 'Z'-axis (vertical) applications, the use of the pneumatic counter balance and accessory kit is strongly recommended. The pneumatic accessory kit includes a filter-regulator-precision regulator, fittings and 1/8" ID tubing. The pressure in the pneumatic cylinder can be set to provide a balancing force to counter act the effect of gravity. The counter balance force (F_C) is a linear function of the pressure (P) and the cylinder piston area (A_C); $F_C = P \times A_C$. See the following table to set the counter balance force.

F_C	P
0.25 kg	5.2 psi
0.5 kg	10.5 psi
1 kg	21 psi
2 kg	42 psi
4 kg	84 psi

The yaw force generated by the counter balance will add 0.2 arc-sec of yaw per psi of pressure.

The Pressure regulation during motion is dependent on the speed and acceleration of the motion profile. The following table shows the expected pressure fluctuation based on the move dynamics.

Acceleration	Velocity	Fluctuation*
1 g	≤ 500 mm/sec	< 1 psi
3 g	≤ 500 mm/sec	< 2 psi
3 g	≤ 2000 mm/sec	< 3 psi

* 1 psi = 1.68oz (0.47 N) of force

Clean Room Compatibility

The vertical counter balance is compatible with clean rooms of class 250-500 for speeds below 500 mm/sec or class 1000 for higher speeds due to the particle generation on the plunger.

Chapter 4 - Performance

Acceleration Limits

Acceleration of linear servo driven tables is typically limited by three (3) factors; linear bearings, available motor force and settling time. Due to the high load bearings used in the MX80, the acceleration is only limited by the available motor force and the settling time.

- Available Motor Force

This is the primary factor that reduces acceleration. This is simply the amount of motor force available to produce acceleration. The larger the inertial and or frictional load the lower the accelerations limit.

- Settling Time

In many applications reducing cycle time is a primary concern. To this end, the “settling” time (the amount of time needed after a move is completed for table and load oscillating to come within acceptable limits) become very important. In many cases where very small incrementing moves are executed, the settling time is greater than the actual move time. In these cases accelerations may need to be reduced thus reducing the settling time.

Speed Limits

The Maximum Speed of the MX80L is limited by three (3) factors:

- Travel Length

The short travel length of the MX80L is the main limiting factor for maximum speed. The T01 and T02 options (25mm and 50mm) a triangular motion profile with 5g accel/decel will only yield peak speeds of 1.1m/sec and 1.5 m/s respectively.

- Linear Encoder Limit

The linear encoder has speed limits relative to encoder resolution; these limits are listed below:

Encoder Resolution	Maximum Velocity	Required Post Quadrature Input Bandwidth ^(?)
5 micron	5 meters/second ⁽¹⁾	2 MHz
1 micron	3 meters/second(1)	6.7 MHz
0.5 micron	1.5 meters/second	6.7 MHz
0.1 micron	0.3 meters/second	10 MHz
0.02 micron	0.06 meters/second	10 MHz
0.01 micron	0.03 meters/second	10 MHz

⁽¹⁾ When using an encoder with 5 micron resolution, velocity limited by speed dependant force.

^(?) This is the bandwidth frequency that the amplifier or servo control input should have to operate properly with the encoder output at maximum speeds. This frequency is post-quadrature, to determine pre-quadrature divide above values by 4. Above frequencies include a safety factor for encoder tolerances and line losses.

- Force / Speed Limit

The available force of the MX80L reduces as speed increases. (Chapter 2, *MX80L Series Technical Data*)

Thermal Effects on Accuracy

The MX80L uses a moving magnet linear servo motor. The magnet rails and the encoder tape are mounted to the carriage. The motor coils are mounted in the base and unless the table is mounted to an insulated surface, the heat generated in the coils should radiate out the base maintaining a low thermal delta between base and carriage. All specifications for the MX80L are taken at 20 C. Variation from this temperature will cause additional positional errors. If the carriage of the MX80L varies from this temperature the encoder scale will expand or contract, thus changing its measuring length and thus encoder resolution.

The factor by which this thermal effect occurs is 0.000022mm/mm/° C. Although this sounds like a very small number it can make significant accuracy and repeatability effects on your applications, especially on longer travel applications. To understand this better let's look at an example:

Example: A standard grade MX80L with 150mm travel is being used. The accuracy over the entire travel is 25 microns @ 20° C. If the carriage temperature increases by 5 C an additional error of 17 microns will be added over the total travel (0.000022mm/mm/° C)*150mm*5 C. However, this additional error can be compensated for since the error is linear.

The accuracy of the MX80L is plotted with respect to carriage temperature in the graph below for the 25 mm, 50 mm, 100 mm and 150 mm travel lengths.

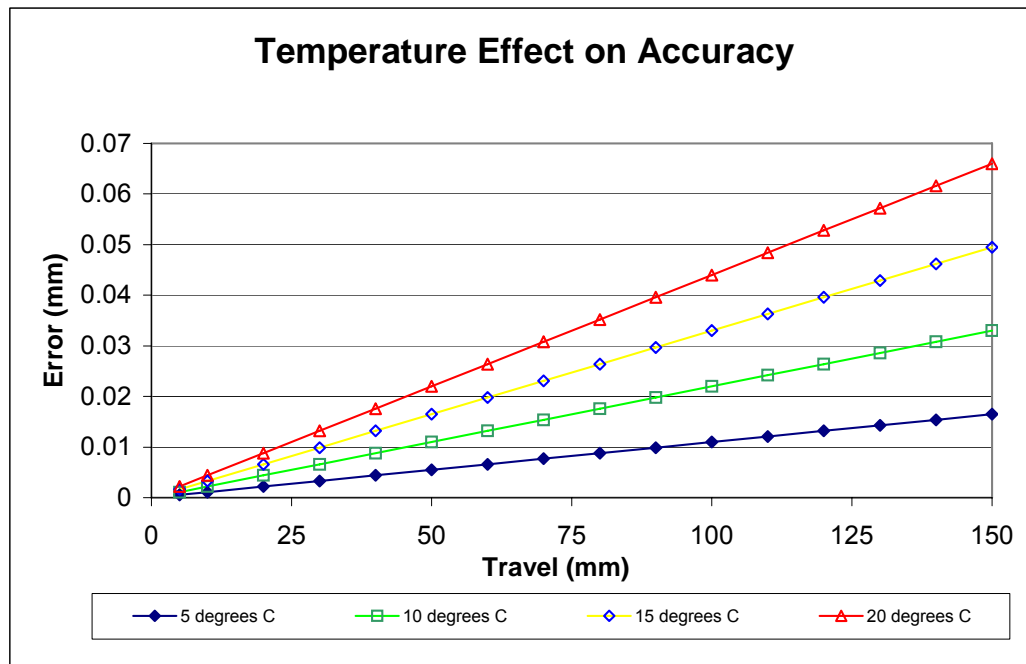

Thermal Effects on Repeatability

Repeatability will not be affected as long as the temperature remains constant. However the repeatability will be affected as the temperature changes from one level to another. This is most commonly experienced when starting an application cold. Then as the application runs the MX80L comes to its operational temperature. The positions defined when the unit was “cold” will now be offset by the thermal expansion of the unit. To compensate for this offset, all positions should be defined after the system has been exercised and brought to operational temperature.

Causes of Temperature Increases

One or more of the following conditions may affect the temperature of the MX80L carriage:

- Ambient Temperature

This is the air temperature that surrounds the MX80L

- Application or Environment Sources

These are mounting surfaces or other items which produce a thermal change that affect the temperature of the MX80L carriage (i.e. X/Y configurations with motors or other heat generating devices that heat the mounting surface and thus thermally affect the MX80L carriage).

- Motor heating from MX80L

Since the MX80L uses a servo motor as its drive, it produces no heat unless there is motion, or a force being generated. In low duty cycle applications heat generation is low, however as duty cycles increase, temperature of the MX80L will increase, causing thermal expansion of the base. With very high duty cycles these temperatures can reach temperatures as high as 30° C above ambient.

Compensating for Thermal Effects

If the application requires high accuracy, the thermal effects must either be removed by regulating carriage temperature or compensated for with a correction factor added to the commanded position. *Controlling the carriage temperature* is the best method. However, this means controlling the ambient temperature by removing all heat/cold generators from the area and operating at very low duty cycles. *Compensation* is the other way of achieving accuracy without sacrificing performance. In this case the system must be exercised through its normal operating cycle. The temperature of the carriage should be measured and recorded from the beginning (cold) until the carriage becomes thermally stable. This carriage temperature should be used in a compensation equation. Below is the fundamental *thermal compensation equation*:

$$C_d = (I_d - ((I_d) * (T_e) * \Delta T))$$

C_d = Corrected displacement (mm)

I_d = Incremental displacement (mm)

T_e = Thermal Expansion (0.000022 mm/mm/° C)

ΔT = Temperature Differential from 20° C

Example:

- Carriage Temperature of 32° C required move of 100mm

$$C_d = 100\text{mm} - (100\text{mm} * T_e * 12^\circ \text{C}) = 99.9736\text{mm}$$

In this example the commanded move should be 26.4 microns less (100mm – 99.9736mm) than the desired move. This will compensate for the thermal expansion of the scale. This is a simple linear correction factor and can be programmed in to most servo controllers using variables for the position commands.

Chapter 5 - Connecting to the ViX

The MX80L is designed to be plug and run compatible with the Parker ViX drive. The cables on the MX80L are labeled to match the labels on the ViX for ease of use and quick installation. When purchased as part of the part number, the ViX will have the motor parameters already downloaded.

X1 – MOTOR LEADS	
WIRE COLOR	DRIVE
RED	U
WHITE	V
BLACK	W
GREEN	GND

X2 – FEEDBACK-HALL CONNECTOR		
PIN	FUNCTION	WIRE COLOR
1	Encoder Z+	ORANGE
2	Encoder Z-	BROWN
3	GND	BLACK
5	+5V	RED
6	Temperature-	YELLOW/BLACK
7	Encoder A+	WHITE
8	Encoder A-	YELLOW
9	Hall#1	WHITE/BROWN
10	Temperature+	YELLOW/RED
11	Encoder B-	BLUE
12	Encoder B+	GREEN
13	Hall#2	WHITE/ORANGE
14	Hall#3	WHITE/VIOLET

X5 – LIMITS CONNECTOR*		
PIN	FUNCTION	WIRE COLOR
1	GND	BLACK
6	+ End of travel	ORANGE
7	- End of travel	BLUE
8	Home	GREEN

* For Drive Only versions of the ViX, the limits need to be connected to the motion controller NOT the drive.

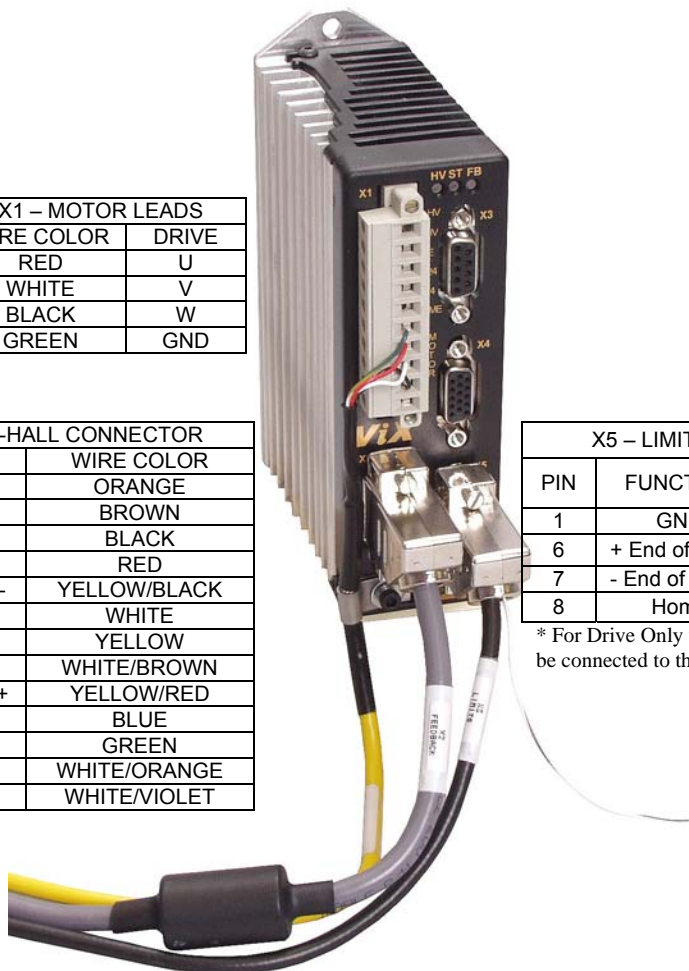

Limits use Inputs

The ViX drive has 5 digital inputs. When using with MX80L, the EOT Limits and Home use 3 of the 5 inputs. A VM15-PF screw terminal breakout board may be purchased to allow access to the remaining 2 inputs and all of the outputs.

Chapter 6 - Maintenance and Lubrication

Cross Roller Bearing Lubrication

Standard Prep:

- Recommended Lubricant: Mobil Vactra No. 2, oil
- Lubrication Interval: 1000 hours*
- Method:

Lightly coat the bearing surfaces with oil. Bearings surfaces can be exposed by moving the table to the end of travel lubricating the now exposed surfaces, then moving the table to the other end of travel and lubricating the other set of surfaces.



Warning

Excessive oiling of the bearings--particularly the limit side bearing--can cause unit to malfunction. Excess oil can damage limit sensor and target.

Clean Room Prep:

- Recommended Lubricant: Castrol Braycote 803, grease
- Lubrication Interval: 2000 hours*
- Method:

Lightly coat the bearing surfaces with grease. Bearings surfaces can be exposed by moving the table to the end of travel lubricating the now exposed surfaces, then moving the table to the other end of travel and lubricating the other set of surfaces.



Warning

Excessive greasing of the bearings--particularly the limit side bearing--can cause unit to malfunction. Excess grease can damage limit sensor and target.

* General notes: Shorter lubrication interval may be required in environments with high amounts of dust and other contamination.

Appendix A - Internal Protection

Daedal has conducted testing to determine the *degree* to which the positioner is protected by using a British standard called an **Ingress Protection Rating (IP Rating)**. The MX80L has an IP 10 protection rating.

Definition

Reference: British standard EN 60529 : 1992

This standard describes a system of classifying degrees of protection provided by enclosures of electrical equipment. Standardized test methods and the establishment of a two digit numeric rating verify the extent of protection provided against access to hazardous parts, against ingress of solid foreign objects, and against the ingress of water.

First Number – The first number indicates protection of persons against access to dangerous parts and protection of internal equipment against the ingress of solid foreign objects.

1 - Protection against access to hazardous parts with the back of a hand, and protected against solid foreign objects of 50 mm diameter and larger.

Second Number – The second number indicates protection of internal equipment against harmful ingress of water.

0 - No special protection provided.

Note: Number Indicators above represent only a partial list of IP Rating specifications.



Warning

Particles as small as 0.005" diameter could lodge between the table and internal components causing the motor to stall.

Appendix B - EC Declaration of Conformity



EC DECLARATION OF CONFORMITY

Name of Authorised Representative: Parker Hannifin Corporation
Electromechanical Automation, NA Division

Address of Authorised Representative: 1140 Sandy Hill Road
Irwin, PA 15640 USA
tel (800) 425-6903 fax (724) 861-3330

Equipment: MX80L Electromechanical Linear Positioning System

Description of Equipment: Non-contact Linear Servo Motor with High Precision Linear Encoder
See the User Guide for a full description of function.

Year in which CE mark affixed: 2011

The above equipment conforms to the requirements of Council Directive 2006/95/EC (Low Voltage Directive) when installed, operated and maintained as intended.

The installation requirements are detailed in the User Guide supplied with the equipment.

Compliance is demonstrated by the application of the following standards:

BS EN 60034-1 (2004) including Amendment No. 1	Rotating Electrical Machines – Part 1. Rating and Performance
BS EN 60204-1 (2006) +A1:2009	Safety of Machinery – Electrical Equipment of Machines - Part 1. General Requirements

Signed:

Date: 4-18-2011



Position:

James Monnich
Engineering Manager, Parker Hannifin EMN, NA

Index

- Acceleration
 - Limits, 36
 - Specifications, 14
- Accuracy
 - Specifications, 14
 - Thermal Effects, 37, 38
- Assembly Diagram, 9, 39

- Bearing
 - Life, 16
 - Load, 21
 - Lubrication, 40
- Bend Radius**, 34

- Cabling, 34, 35
- Cleanroom, 25, 35, 40
- Compax3
 - Drive Specifications, 26
- Counter Balance, 35

- Deceleration Distance, 31
- Dimensional Drawings, 11

- Electrostatic Discharge (ESD), 26
- Encoder, 33, 36, 37
 - Resolution, 36
 - Specifications, 26
 - Velocity Limit, 36

- Force/Speed Charts, 23, 25

- General Specifications, 14
- Grounding, 34

- Hall Effect
 - Specifications, 26
- Home Sensor
 - Adjusting, 33
 - Specifications, 26
 - ViX, 39
- Horizontal Translation, 21

- Ingress Protection Rating, 41
- Internal Protection, 41, 42

- Limit Sensor
 - Adjusting, 32
 - Specifications, 26
 - ViX, 39
- Lubrication, 40

- Maintenance, 40
- Mass, 14
- Motor Force, 36
- Motor Heating, 38
- Mounting, 29
 - Surface Requirements, 29, 30

- Overhang, 30

- Repair Information, 7
- Repeatability, 33
 - Specifications, 14
 - Thermal Effects, 37
- Return Information, 7

- Settling Time, 36
- Shielding, 34

- Specifications
 - Bearing, 16
 - Electrical, 24
 - Encoder, 26
 - Force, 22
 - General, 14
 - Hall Effect Sensors, 26
- Speed
 - Limits, 36
 - Maximum, 31

- Table Load, 16
- Thermal Effects
 - Accuracy, 37
 - Causes, 38
 - Compensation, 38
 - Repeatability, 37
- Thrust
 - Specifications, 14
- Travel
 - Setting Limit Sensors, 31

- Unpacking, 6

- Velocity
 - Maximum, 36
 - Specifications, 14
- ViX
 - Amplifier, 39
 - Drive Specifications, 26

- Warnings, 7
- Wiring Diagrams, 27, 28

- Z Channel, 33